

18 – 40 GHz Low Noise Amplifier

Features

- ◆ Frequency Range : 18 - 40GHz
- ◆ Nominal Gain : 19dB
- ◆ Noise Figure : 3dB
- ◆ I/O Return Losses : 7dB
- ◆ Output P1dB : 6dBm
- ◆ Self-bias operation
- ◆ DC decoupled Input and Output
- ◆ Chip Dimension: 1.95mm x 1.13mm x 0.1mm

Functional diagram

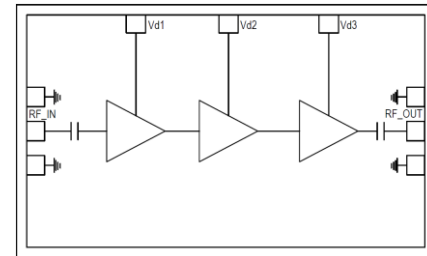

Typical Applications

- ◆ Radar
- ◆ Military
- ◆ Test Equipment and Sensors.

Description

The ASL1030 is a Low Noise Amplifier operating in 18.0 – 40.0GHz frequency range. The LNA uses 3 stages of amplification and provides 19dB of typical gain with noise figure less than 3.6dB having input & output return losses better than 7dB. The LNA has P1dB of 6dBm over the entire operating frequency band and operates on +3V DC supply with a current consumption of 46mA (typ). The circuit grounds on the die are provided through vias to the backside metallization

Absolute Maximum Ratings¹

Parameter	Absolute Maximum	Units
Positive DC voltage	+6	V
RF input power	+20	dBm
Operating Temperature	-55 to +85	°C
Storage Temperature	-65 to +150	°C

1. Operation beyond these limits may cause permanent damage to the component.

Electrical Specifications @ $T_A = 25\text{ }^\circ\text{C}$, $V_d = +3\text{V}$, $Z_o = 50\Omega$,

Parameter	Min.	Typ.	Max.	Units
Frequency	18		40	GHz
Gain	-	19	-	dB
Gain Flatness	-	± 1	-	dB
Noise Figure	2.3	3	3.6	dB
Input Return Loss	-	5	-	dB
Output Return Loss	-	5	-	dB
Output Power (P1dB)		6		dBm
Supply Voltage		3		V
Supply Current		46		mA

Note:

1. The above mentioned electrical specifications are measured On-Wafer.

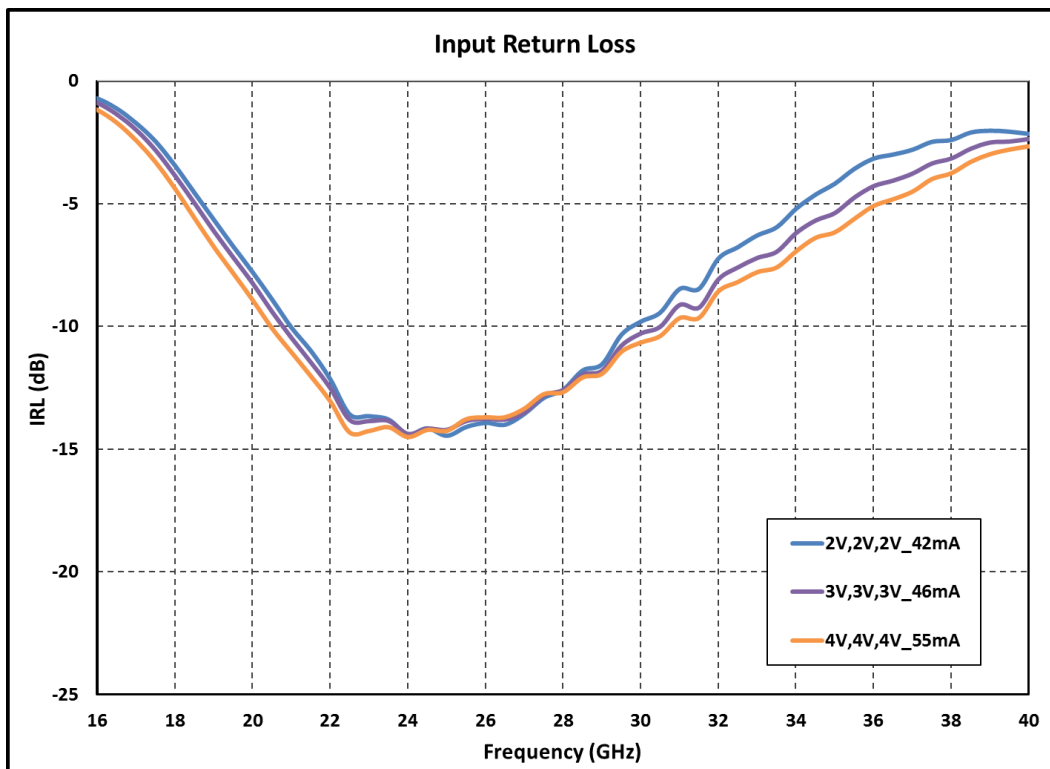
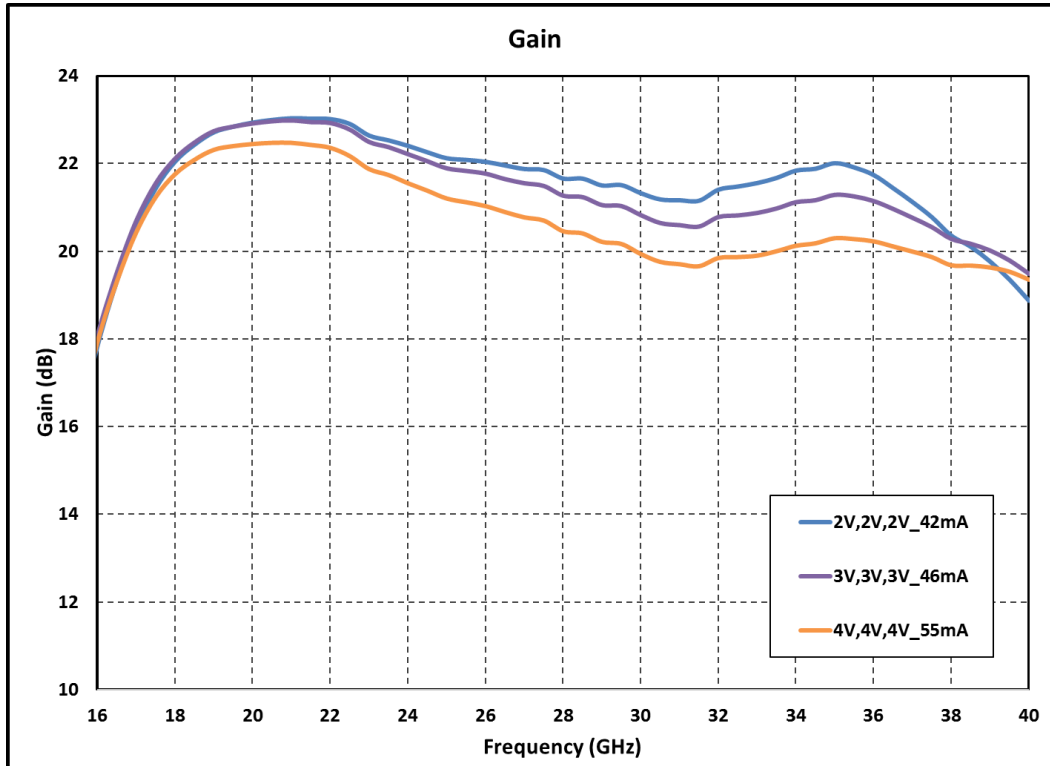
On-wafer Probed data
 $V_{d1} = V_{d2} = V_{d3} = 3V$, Total Current = 46 mA, $T_A = 25\text{ }^\circ\text{C}$

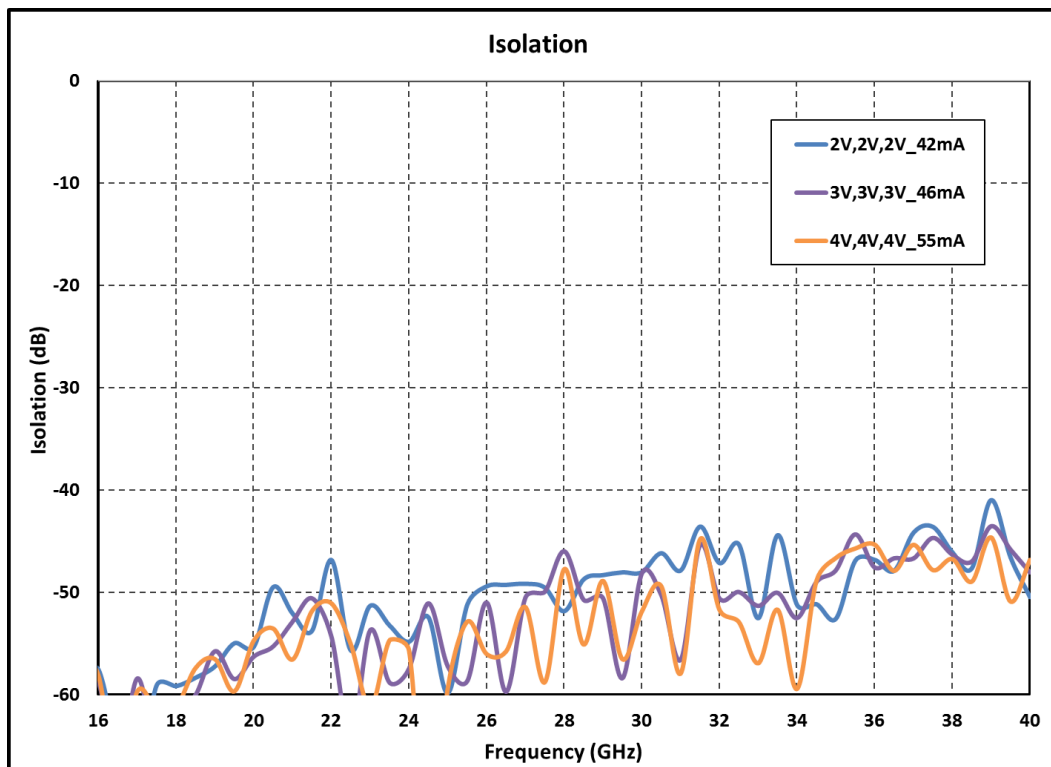
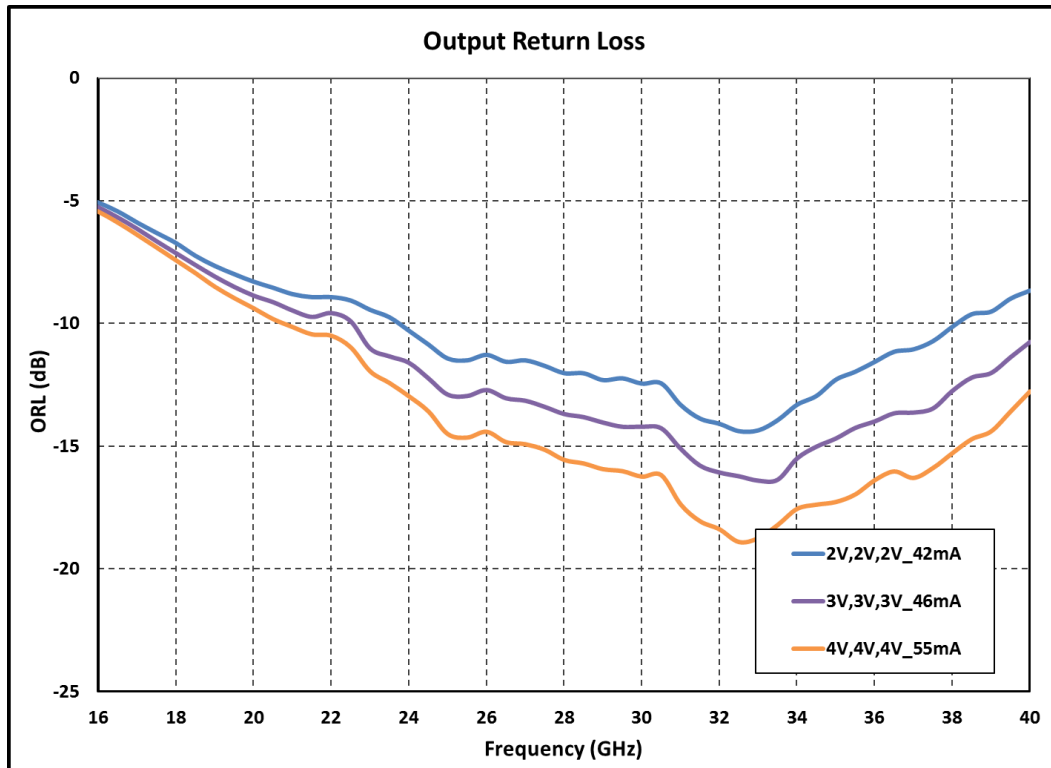
On-wafer Probed data
 $V_{d1} = V_{d2} = V_{d3} = 3V$, Total Current = 46 mA, $T_A = 25^\circ C$

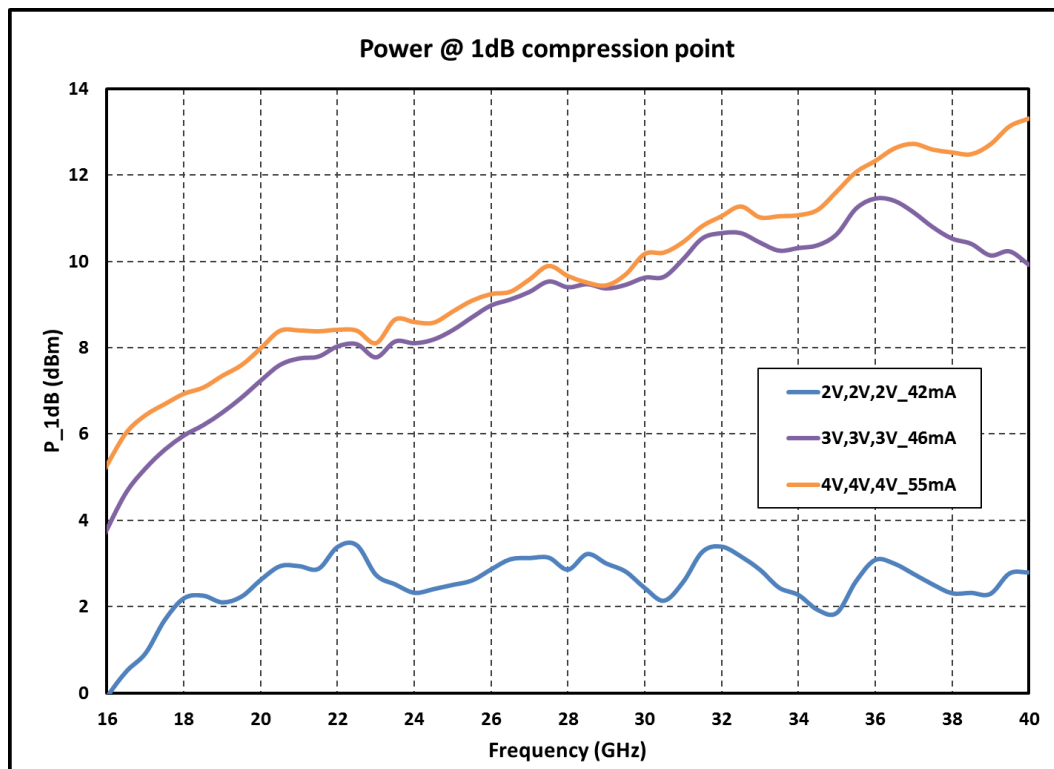
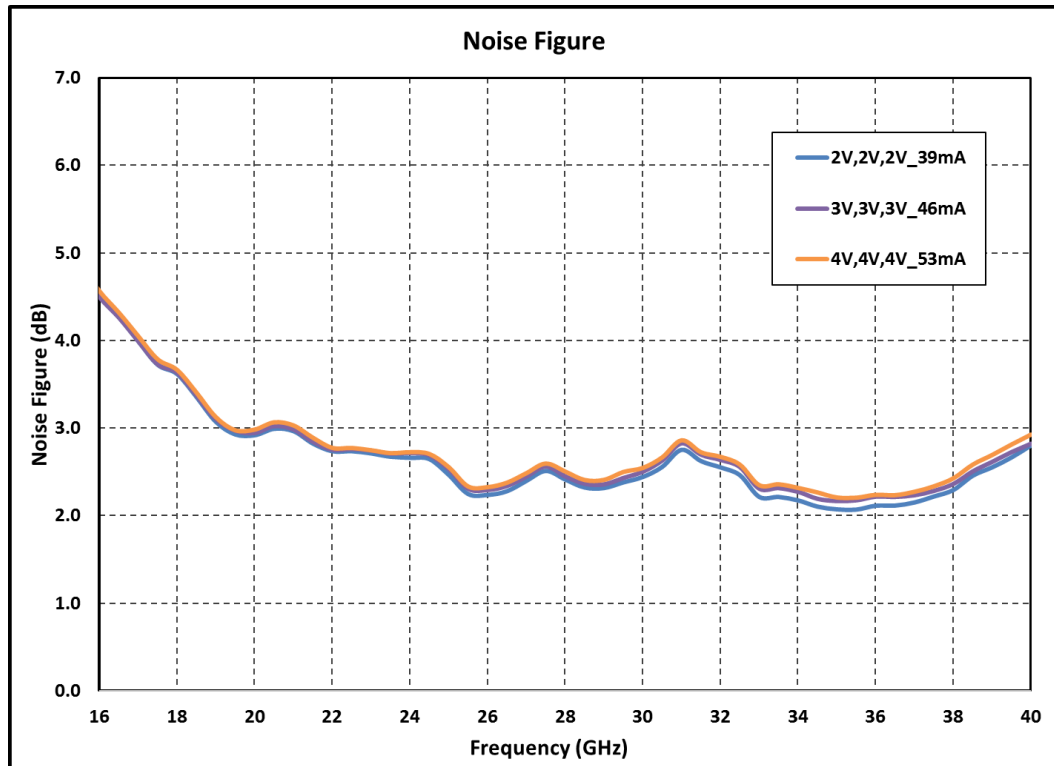
On-wafer Probed data
 $Vd1= Vd2= Vd3= 3V, Total\ Current = 46\ mA, T_A = 25\ ^\circ C$

Mechanical Characteristics

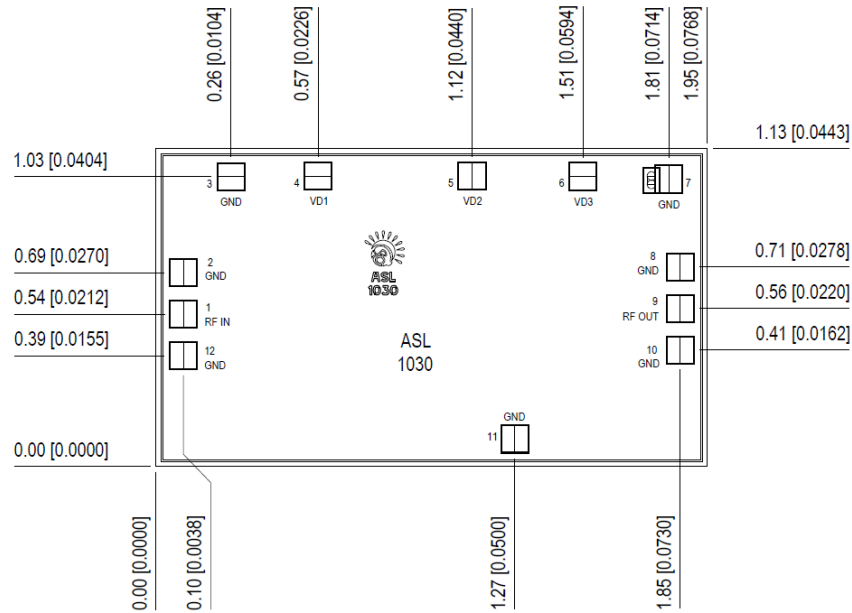

Units: millimeters (inches)

All RF and DC bond pads are 100µm x 100µm

Note:

- | | | |
|-----------------------------------|---|--------|
| 1. Pad no. 1 | : | RF IN |
| 2. Pad no. 4 | : | VD1 |
| 3. Pad no. 5 | : | VD2 |
| 4. Pad no. 6 | : | VD3 |
| 5. Pad no. 9 | : | RF OUT |
| 6. Pad no. 2, 3, 7, 8, 10, 11, 12 | : | GND |

Recommended Assembly Diagram

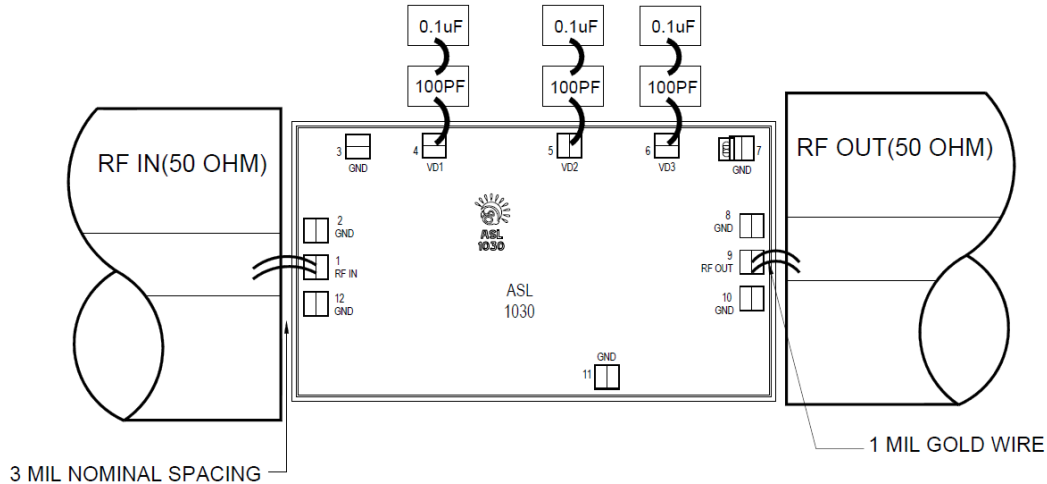

Note:

1. Two 1 mil (0.0254mm) bond wires of minimum length should be used for RF input and output.
2. 100pF and 0.1 μ F capacitors may be additionally used as a second level of bypass at the power supplies for reliable operation.

Die attach: For Epoxy attachment, use of a two-component conductive epoxy is recommended. An epoxy fillet should be visible around the total die periphery. If Eutectic attachment is preferred, use of fluxless AuSn (80/20) 1-2 mil thick preform solder is recommended. Use of AuGe preform should be strictly avoided.

Wire bonding: For DC pad connections use either ball or wedge bonds. For best RF performance, use of 150 - 200 μ m length of wedge bonds is advised. Single Ball bonds of 250-300 μ m though acceptable, may cause a deviation in RF performance.



GaAs MMIC devices are susceptible to Electrostatic discharge. Proper precautions should be observed during handling, assembly & testing.

All information and Specifications are subject to change without prior notice.