

1 - 22 GHz Wideband Amplifier

Features

- ◆ Frequency Range: 1.0 – 22.0GHz
- ◆ 12dB Nominal gain
- ◆ Noise Figure: 2.1 @ 8GHz
- ◆ P1 dB: 10 dBm at 10GHz.
- ◆ Input Return Loss > 12 dB
- ◆ Output Return Loss > 12 dB
- ◆ DC decoupled input and output
- ◆ 0.15 μm InGaAs pHEMT Technology
- ◆ Chip dimension: 3.0 x 1.2 x 0.1 mm

Functional Diagram

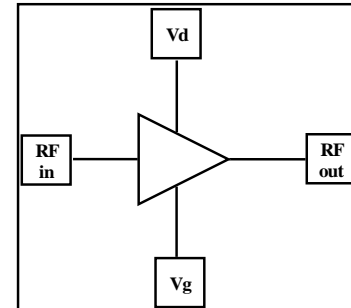

Typical Applications

- ◆ Wideband LNA/Gain block
- ◆ Electronic warfare
- ◆ Test Instrumentation

Description

The ASL5002 is a broadband pHEMT GaAs MMIC TWA designed to operate over 1GHz to 22 GHz frequency range. The design employs 6 cascode pHEMT cells in a distributed amplifier topology, to ensure larger bandwidth, flat gain and good return losses. The device offers a typical small signal gain of 11 dB over the operating frequency band and has a Noise figure less than 4 dB in 2-20GHz band. The P1dB is 10dBm at 10GHz. The Input & output are matched to 50Ω with a VSWR better than 1.6:1. The chip is unconditionally stable over the entire operating frequency range.

The ASL5002 is suitable for a variety of wideband electronic warfare systems such as radar warning receivers, jammers and instrumentation. In addition, the chip may also be used as a predriver or a gain block.

Absolute Maximum Ratings⁽¹⁾

Parameter	Absolute Maximum	Units
Positive DC voltage	+8	V
RF input power	+16	dBm
Supply Current	150	mA
Storage Temperature	-55 to +150	$^{\circ}\text{C}$
Operating Temperature	-40 to +85	$^{\circ}\text{C}$

1. Operation beyond these limits may cause permanent damage to the component

Electrical Specifications @ $T_A = 25\text{ }^\circ\text{C}$, $Z_o = 50\ \Omega$, $V_d = 2\text{V}$, $V_g = -0.25\text{V}$

Parameter	Min.	Typ.	Max.	Units
Frequency Range	1.0	–	22.0	GHz
Gain	10	12	-	dB
Gain Flatness	–	± 1.3	–	dB
Noise Figure (mid-band)	-	2.5	-	dB
Input Return Loss	10	12	–	dB
Output Return Loss	10	12	–	dB
Output Power (P1 dB)	–	10	–	dBm
Third Order Intercept point	–	19	–	dBm
Supply Current	–	55	65	mA

Note:

1. Electrical specifications mentioned above are measured in a test fixture.
2. For optimal performance, the gate voltage V_g should be tuned to achieve a drain current of 55mA.
3. The negative gate supply (V_g) can be tuned from 0V to -0.3V

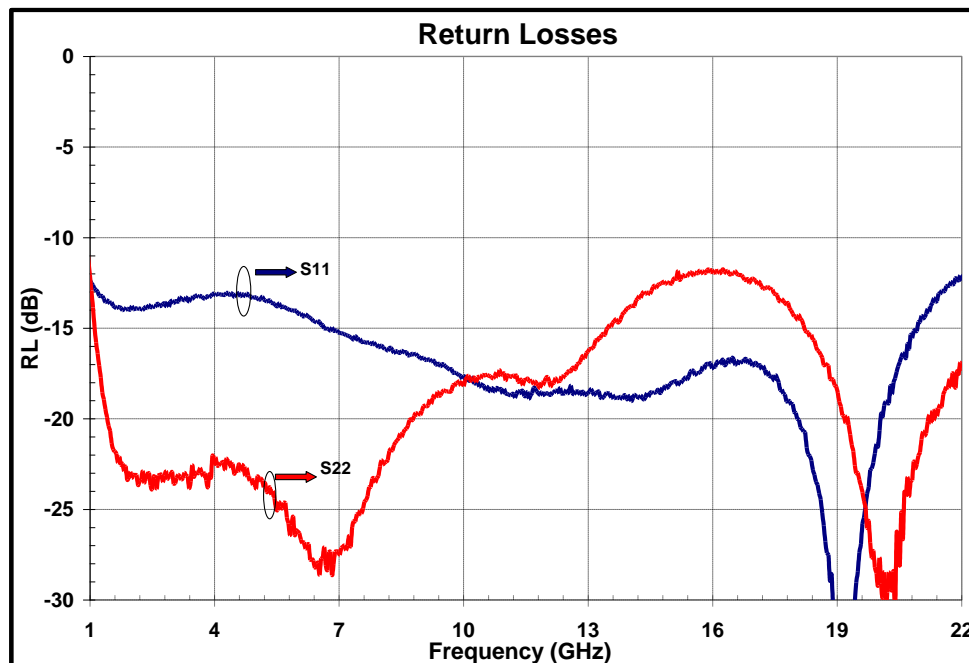
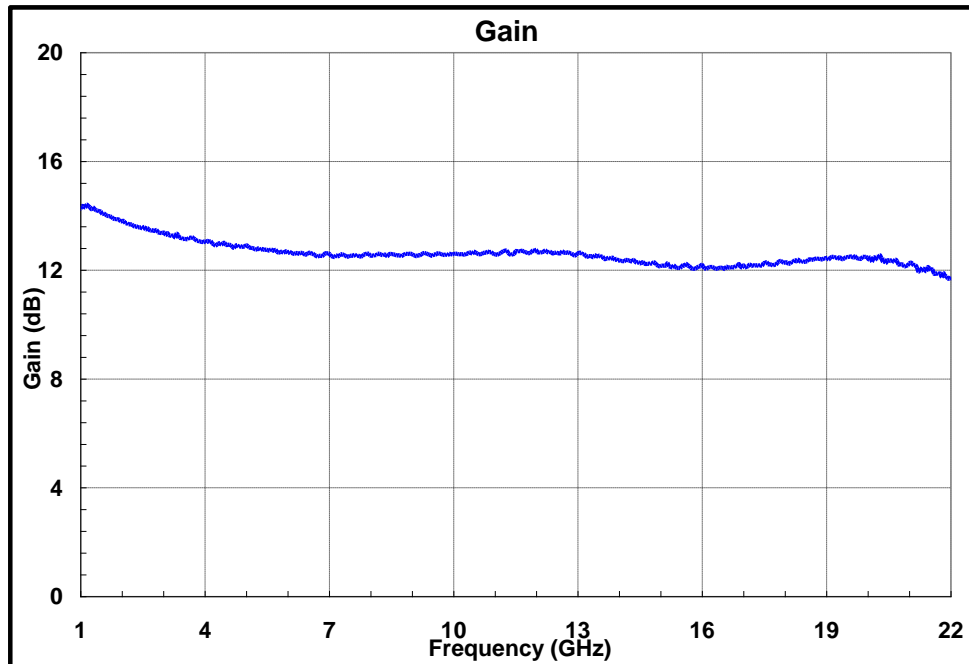
Test fixture data $V_d = +2V$, $V_g = -0.25V$, Total Current = 55 mA, $T_A = 25\text{ }^\circ\text{C}$ 

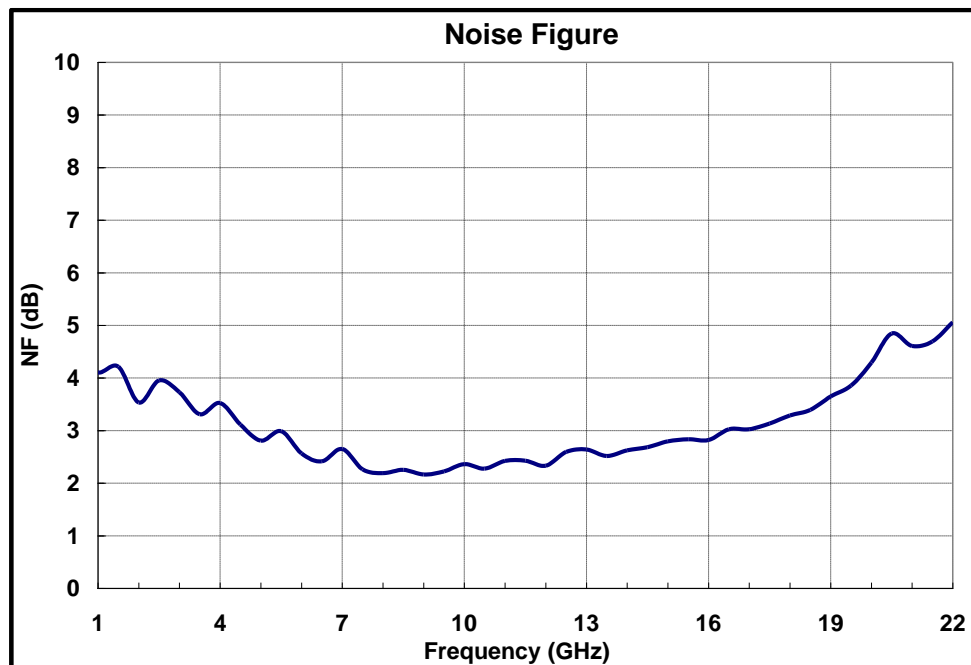
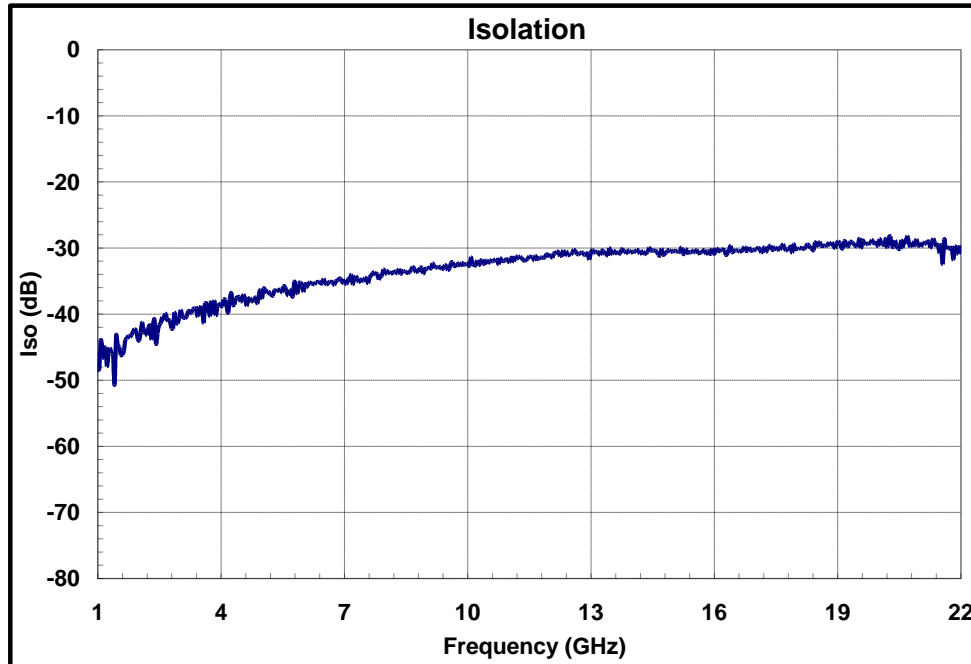
Test fixture data $V_d = +2V$, $V_g = -0.25V$, Total Current = 55 mA, $T_A = 25\text{ }^\circ\text{C}$ 

Mechanical Characteristics

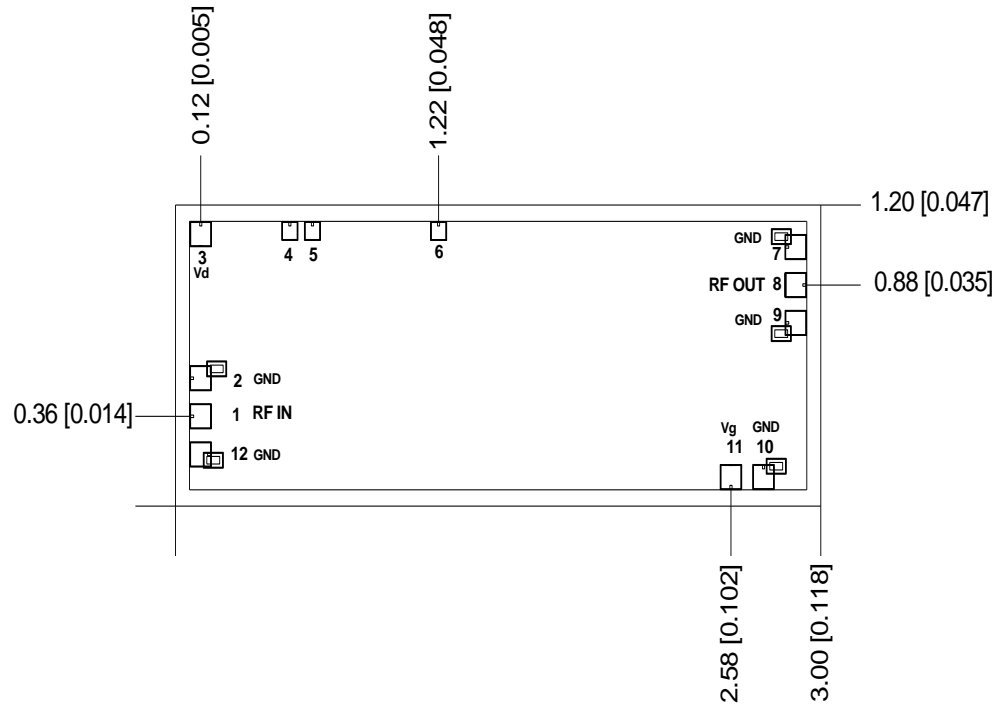

Units: millimeters (inches)

Note:

1. All RF and DC bond pads are 100µm x 100µm
2. Pad no. 1 : RF In
3. Pad no. 3 : Vd
4. Pad no. 8 : RF out
5. Pad no. 11 : Vg

Recommended Assembly Diagram

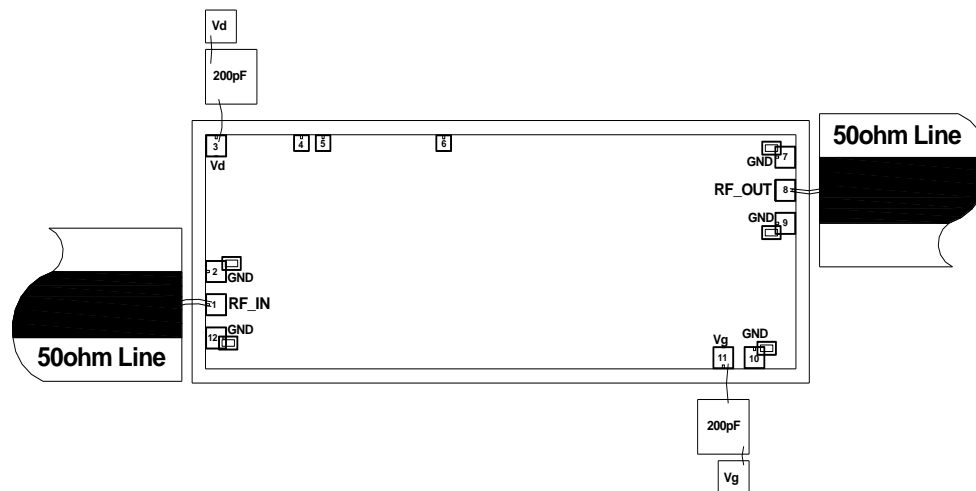
Note:

1. Two 1 mil (0.0254mm) bond wires of minimum length should be used for RF input and output.
2. Input and output 50 ohm lines are on 5mil Alumina/RT Duroid substrate.
3. The supply voltages are $V_d=2.0V$, $V_g=-0.25V$.
4. $0.1 \mu F$ capacitors may be additionally used as a second level of bypass at the power supplies for reliable operation.

Die attach: For Epoxy attachment, use of a two-component conductive epoxy is recommended. An epoxy fillet should be visible around the total die periphery. If Eutectic attachment is preferred, use of fluxless AuSn (80/20) 1-2 mil thick preform solder is recommended. Use of AuGe preform should be strictly avoided.

Wire bonding: For DC pad connections use either ball or wedge bonds. For best RF performance, use of 150 - 200 μm length of wedge bonds is advised. Single Ball bonds of 250-300 μm though acceptable, may cause a deviation in RF performance.



GaAs MMIC devices are susceptible to Electrostatic discharge. Proper precautions should be observed during handling, assembly & testing

All information and Specifications are subject to change without prior notice