

## 4.5 – 5.4 GHz 5 Watt Power Amplifier

### Features

- ◆ Frequency Range : 4.5 – 5.4GHz
- ◆ 36 dBm output P1dB
- ◆ 11 dB Power gain
- ◆ 28% PAE
- ◆ High IP3
- ◆ Input Return Loss > 5 dB
- ◆ Output Return Loss > 10 dB
- ◆ Dual bias operation
- ◆ No external matching required
- ◆ DC decoupled input and output
- ◆ 0.5  $\mu$ m InGaAs pHEMT Technology
- ◆ Chip dimension: 3.96 x 3.11 x 0.1 mm

Functional Diagram

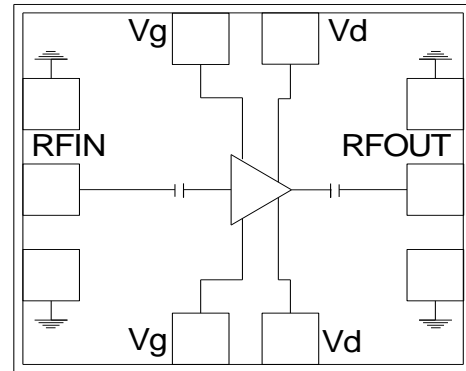

### Typical Applications

- ◆ RADAR
- ◆ MMDS
- ◆ VSAT

### Description

The ASL4002 is a 1 stage C-band power amplifier with 36dBm power output. The PA operates in 4.5 – 5.4 GHz frequency range. The PA features 11 dB of gain with input and output return losses of 5 dB and 10 dB respectively. The PA has a high IP3 of 44dBm and 28% PAE. This feature enables it to be used in the applications requiring efficiency along with linearity. The chip operates with dual bias supply voltage. The die is fabricated using a reliable 0.5 $\mu$ m InGaAs pHEMT technology. The Circuit grounds are provided through vias to the backside metallization.

### Absolute Maximum Ratings <sup>(1)</sup>

Parameter	Absolute Maximum	Units
Drain supply voltage (Vd)	+10	volts
Drain current (Idq)	1.7	A
RF input power (RFin at Vd=10V)	35	dBm
Operating temperature	-50 to +85	°C
Storage Temperature	-65 to +150	°C

1. Operation beyond these limits may cause permanent damage to the component

**Electrical Specifications <sup>(1)</sup>@ T<sub>B</sub> = 40 °C, V<sub>d</sub> = 9V, V<sub>g</sub> = -0.8V, Z<sub>o</sub> =50 Ω**

Parameter	Min.	Typ.	Max.	Units
Frequency Range	4.5		5.4	GHz
Gain	--	11	--	dB
Gain Flatness		+/-1	--	dB
Input Return Loss	--	5	--	dB
Output Return Loss	--	10	--	dB
Output 1dB compression point (P1dB)	--	+36	--	dBm
Output Third Order Intercept point (OIP3) <sup>1</sup>	--	44	--	dBm
PAE <sup>2</sup>	--	28	--	%
Drain Bias Voltage (Vd1, Vd2)	-	9,9	10,10	V
Gate Bias Voltage (Vg1, Vg2)	-1,-1	-0.8,-0.8	-0.7,-0.7	V
Idq	-	1.1	-	A
Idsat	-	1.5	-	A

**Note:**

1. T<sub>B</sub> – MMIC base temperature
2. Measured at output 1dB compression point
3. operating current should be in the range of Idq and Idsat

**Test fixture data**

$V_d = 9V$ ,  $V_g = -0.8V$ ,  $I_{dq} = 1.1A$ ,  $T_B = 40\text{ }^\circ\text{C}$

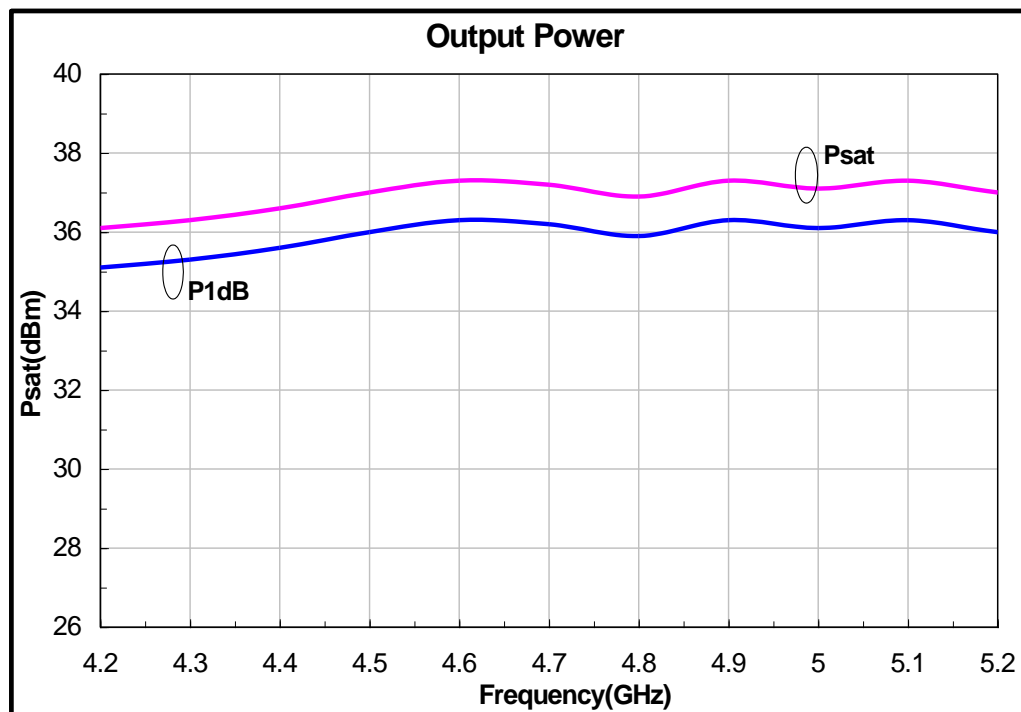
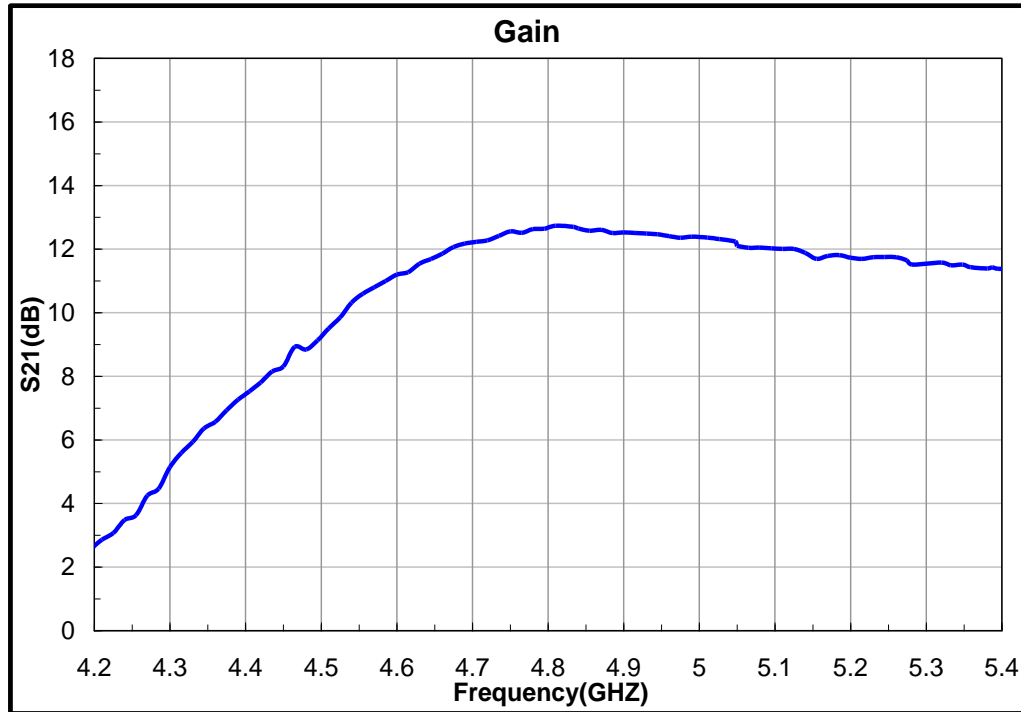

**Test fixture data**

$V_d = 9V, V_g = -0.9V, I_{dq} = 1.1A, T_B = 40^\circ C$

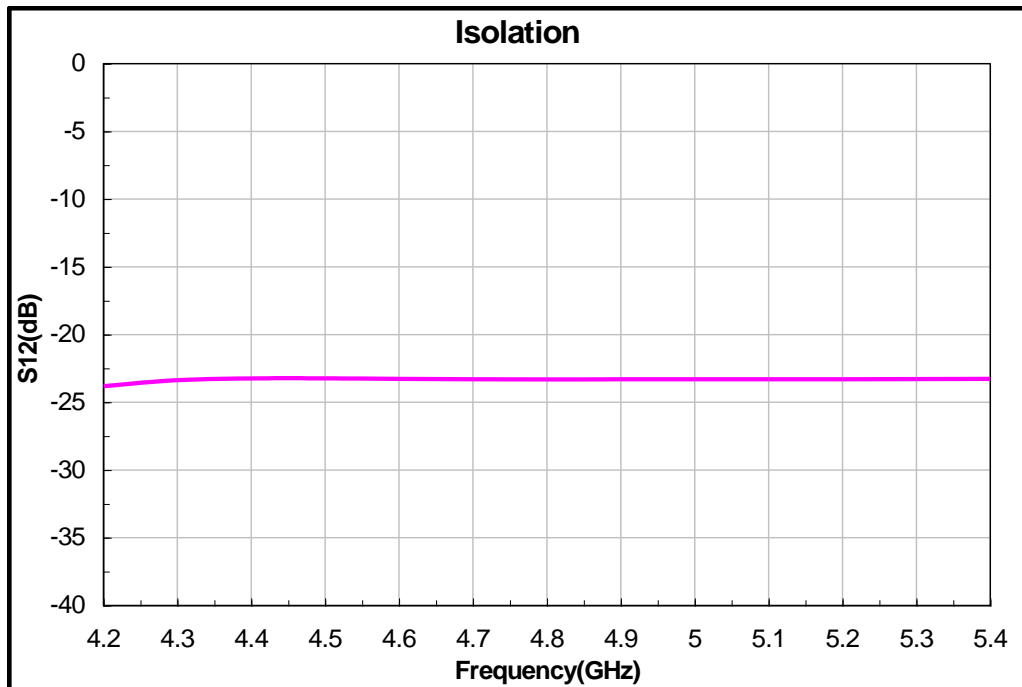
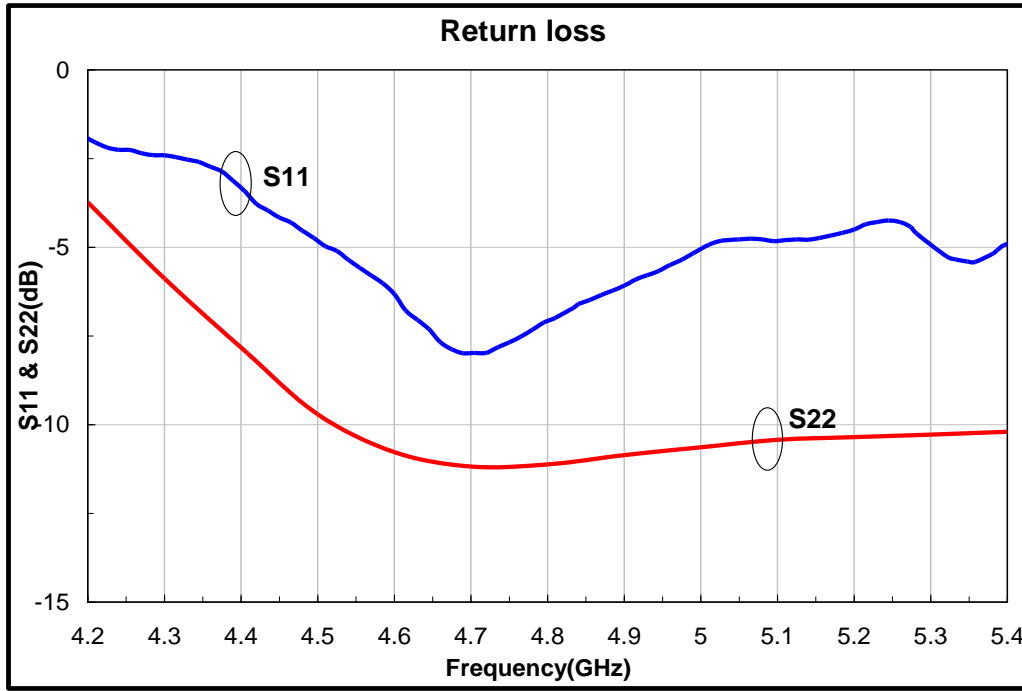

## Mechanical Characteristics

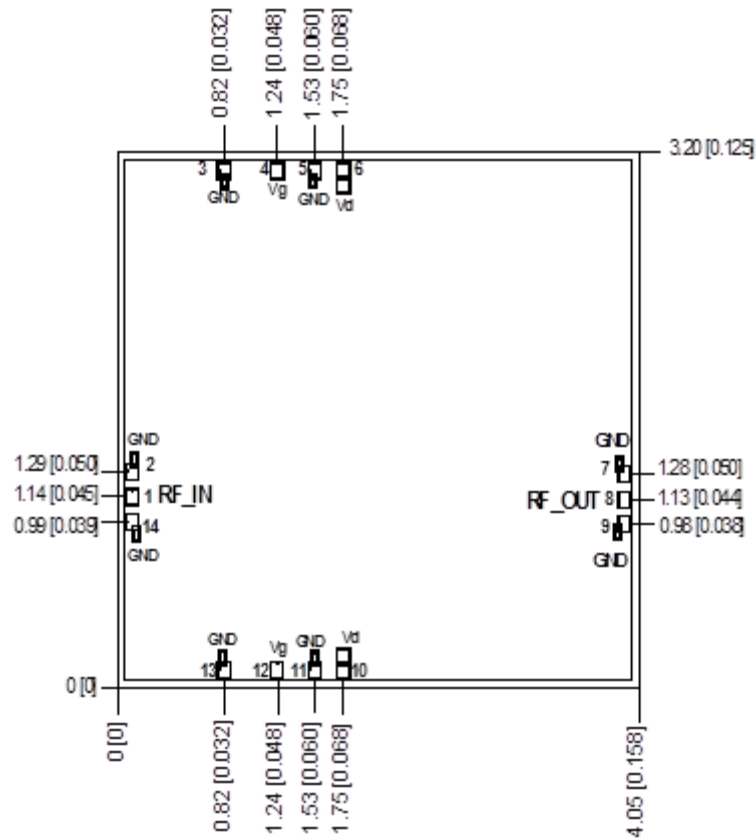

**Units:** millimeters (inches)

**Note:**

1. All RF and DC bond pads are 100µm x 100µm
2. Pad no. 1 : RF IN
3. Pad no. 4,12 : Gate voltage
4. Pad no. 6,10 : Drain voltage
5. Pad no. 8 : RF OUT

## Recommended Assembly Diagram

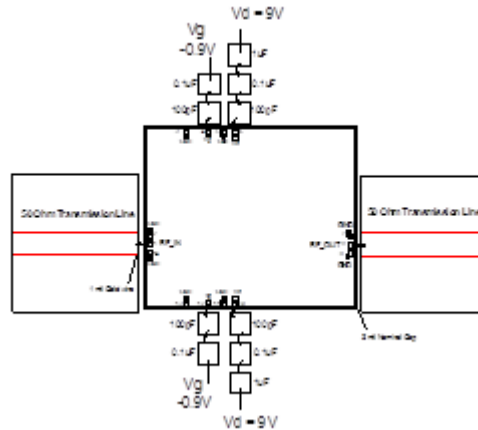

### Note :

1. Two 1 mil (0.0254mm) bond wires of minimum length should be used for RF input, RF output and from chip bond pad to 100pF capacitor.
2. Input and output 50 ohm lines are on 5 mil RT Duroid substrate.
3. The bond numbers shown in assembly diagram are as per bond pad numbers printed on the die.
4. The RF input & output ports are DC decoupled on-chip.
5. Coefficient of thermal expansion matching is recommended for reliability purpose.
6. Use high thermal conductive material for die mounting for long term reliability.
7. Maintain base plate temperature less than 70 degC under RF operation for optimum performance.

**Die attach:** For Epoxy attachment, use of a two-component conductive epoxy is recommended. An epoxy fillet should be visible around the total die periphery. If Eutectic attachment is preferred, use of fluxless AuSn (80/20) 1-2 mil thick preform solder is recommended. Use of AuGe preform should be strictly avoided.

**Wire bonding:** For DC pad connections use either ball or wedge bonds. For best RF performance, use of 150 - 200 $\mu$ m length of wedge bonds is advised. Single Ball bonds of 250-300 $\mu$ m though acceptable, may cause a deviation in RF performance.



***GaAs MMIC devices are susceptible to Electrostatic discharge. Proper precautions should be observed during handling, assembly & testing***

All information and Specifications are subject to change without prior notice