

8 – 11 GHz 1 Watt Power Amplifier

Features

- ◆ Frequency Range : 8 – 11GHz
- ◆ 30 dBm output P1dB
- ◆ 14.5 dB Small Signal Gain
- ◆ 30% PAE
- ◆ High IP3
- ◆ Input Return Loss > 10 dB
- ◆ Output Return Loss > 10 dB
- ◆ Dual bias operation
- ◆ No external matching required
- ◆ DC decoupled input and output
- ◆ 0.5 μm InGaAs pHEMT Technology
- ◆ Chip dimension: 1.9 x 1.0 x 0.1 mm

Functional Diagram

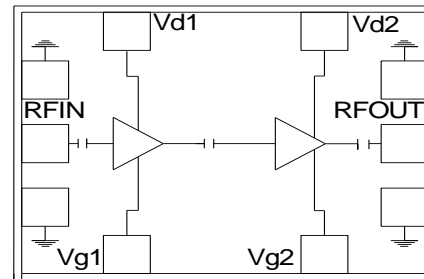

Typical Applications

- ◆ RADAR
- ◆ MMDS
- ◆ VSAT

Description

The ASL4014 is a two stage GaAs PHEMT Class AB Power Amplifier MMIC. The PA delivers output power of 30dBm at 1dB gain compression point with a small signal gain of 14.5dB and 30% PAE. The input/output are matched to 50 ohms and the circuit grounds are provided through vias to the backside metallization.

Absolute Maximum Ratings ⁽¹⁾

Parameter	Absolute Maximum	Units
Drain supply voltage (V_d)	+9	volts
Drain current (I_{dq})	450	mA
RF input power (RFin at $V_d=9V$)	25	dBm
Operating temperature	-50 to +85	$^{\circ}\text{C}$
Storage Temperature	-65 to +150	$^{\circ}\text{C}$

1. Operation beyond these limits may cause permanent damage to the component

**Electrical Specifications ⁽¹⁾ @ $T_B = 40\text{ }^\circ\text{C}$, $V_{d1} = V_{d2} = 8\text{V}$
 $V_{g1} = V_{g2} = -1\text{V}$ $Z_o = 50\text{ }\Omega$**

Parameter	Min.	Typ.	Max.	Units
Frequency Range	8		11	GHz
Gain	12.5	14.5		dB
Gain Flatness		+/- 0.5		dB
Input Return Loss		10		dB
Output Return Loss		10		dB
Output 1dB compression point (P1dB)	+28	+30		dBm
Output Third Order Intercept point (OIP3)		38		dBm
PAE ²		30		%
Drain Bias Voltage (V_{d1} , V_{d2})		8,8	9,9	V
Gate Bias Voltage (V_{g1} , V_{g2})	-1.2,-1.2	-1,-1	-0.7,-0.7	V
Supply Current (I_{dq})		0.36		A
Supply Current (I_{dsat} ³)		0.45		A

Note:

1. T_B – MMIC base temperature
2. Measured at 2dB Gain Compression Point
3. I_{dsat} is the maximum drain current under input RF drive condition

Test fixture data

$V_{d1} = V_{d2} = 8V$, $V_{g1} = V_{g2} = -1V$, $I_{dq} = 360mA$, $T_B = 40\text{ }^\circ\text{C}$

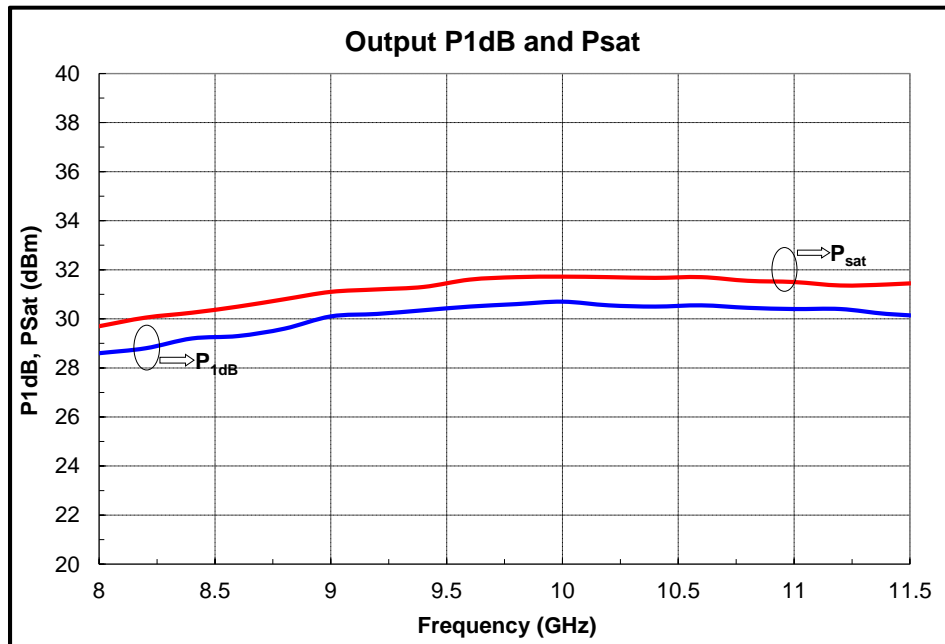
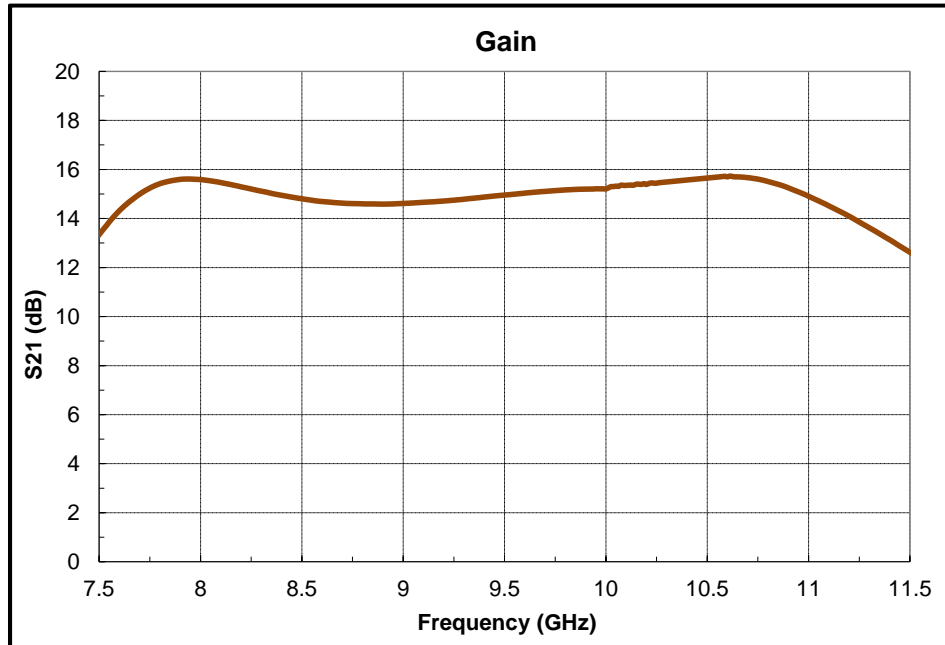

Test fixture data

$V_{d1} = V_{d2} = 8V$, $V_{g1} = V_{g2} = -1V$, $I_{dq} = 360mA$, $T_B = 40\text{ }^\circ\text{C}$

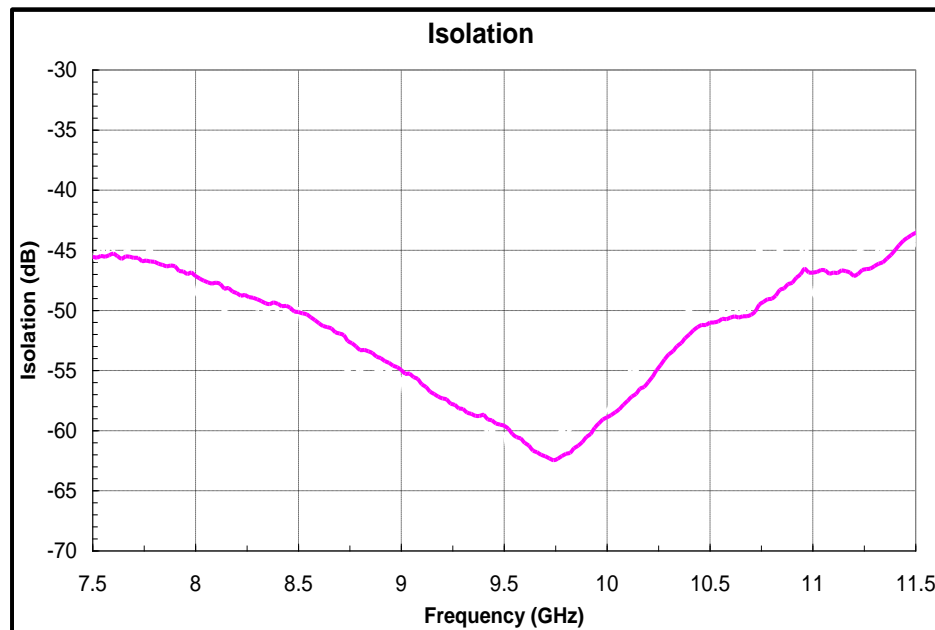
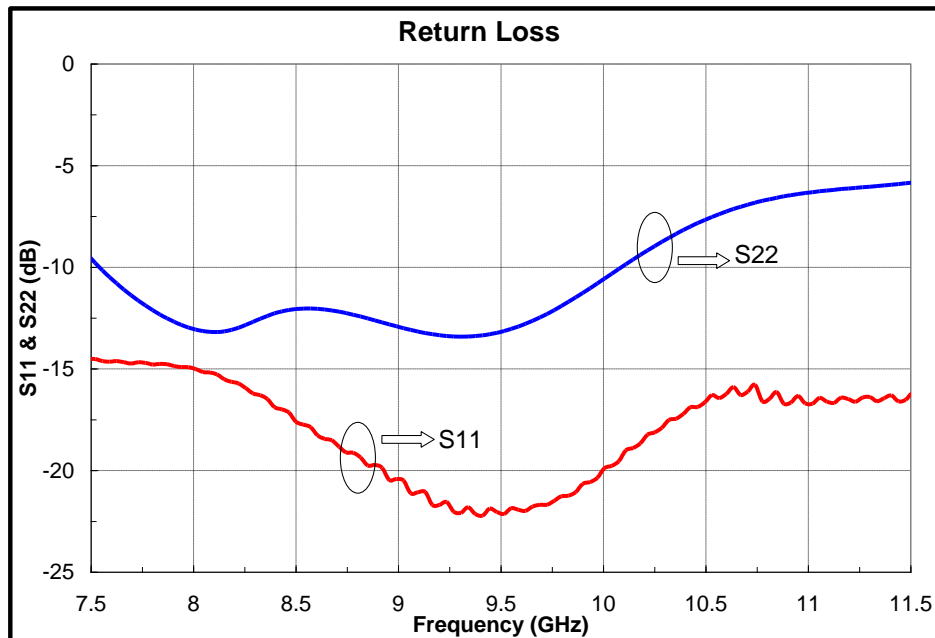

Test fixture data

$V_{d1} = V_{d2} = 8V$, $V_{g1} = V_{g2} = -1V$, $I_{dq} = 360mA$, $T_B = 40^\circ C$

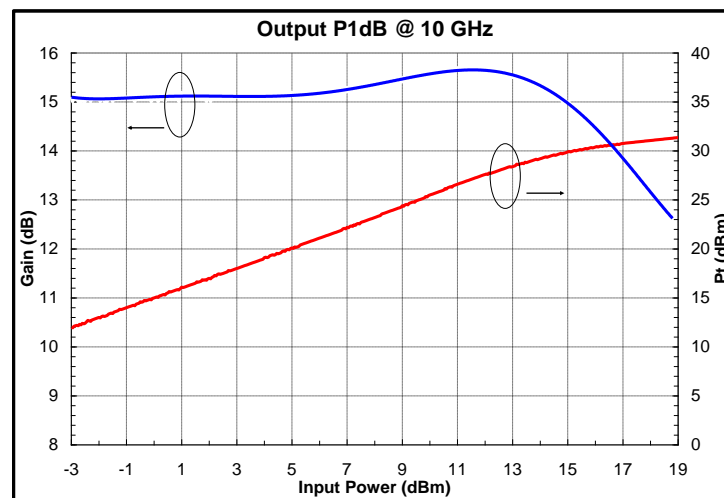
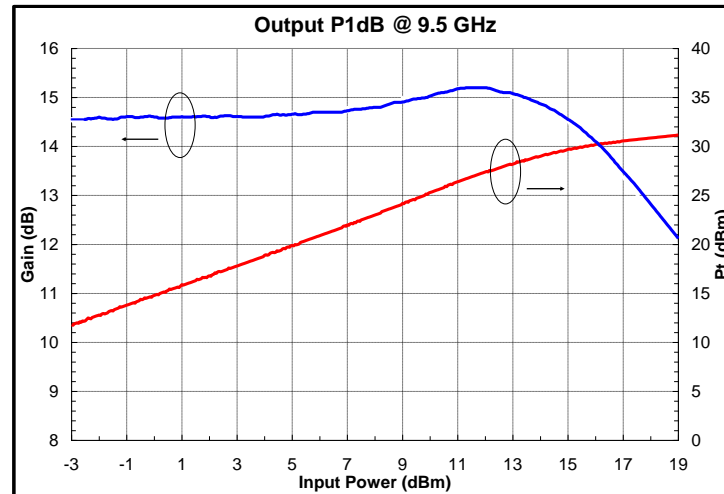
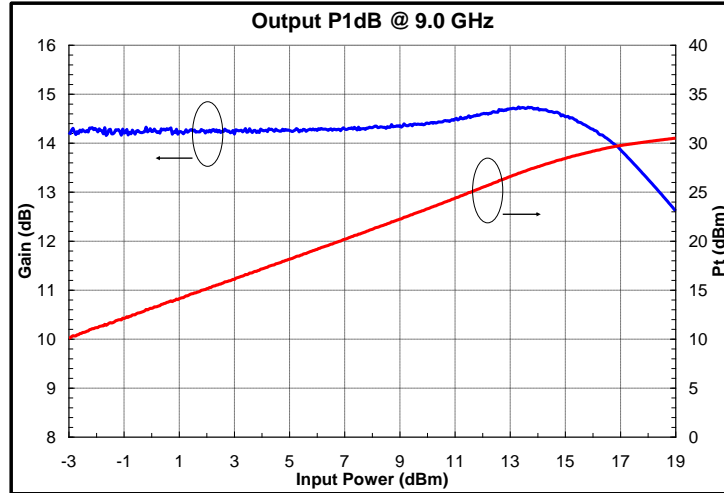

Mechanical Characteristics

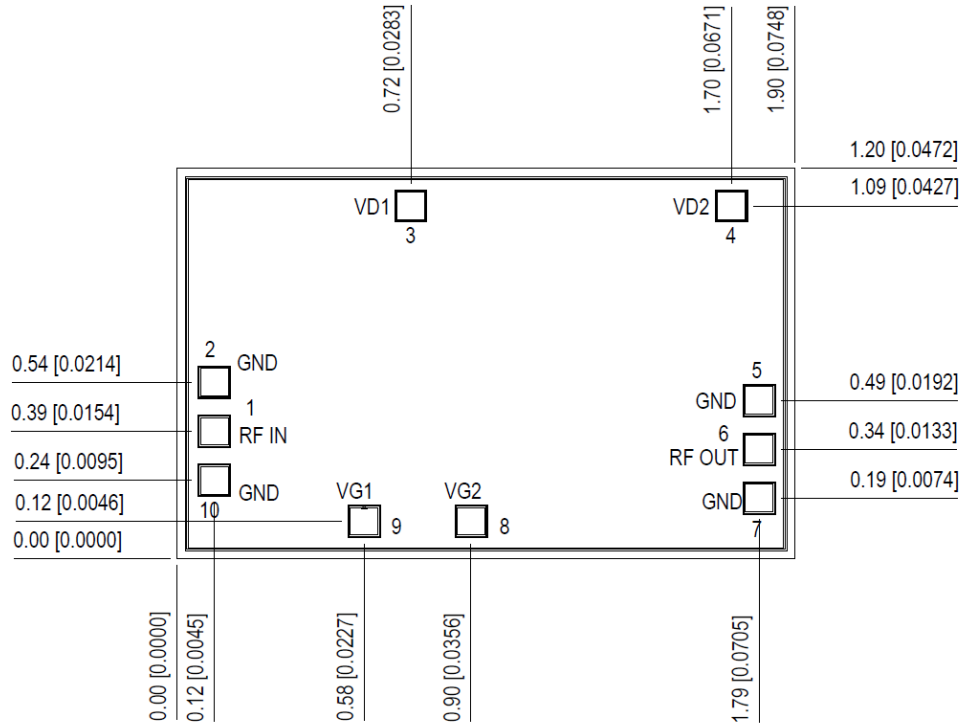

Units: millimeters (inches)

Note:

1. All RF and DC bond pads are 100µm x 100µm
2. Pad no. 1 : RF IN
3. Pad no. 9 : 1st stage gate voltage
4. Pad no. 3 : 1st stage drain voltage
5. Pad no. 8 : 2nd stage gate voltage
6. Pad no. 4 : 2nd stage drain voltage
7. Pad no. 4 : RF OUT

Recommended Assembly Diagram

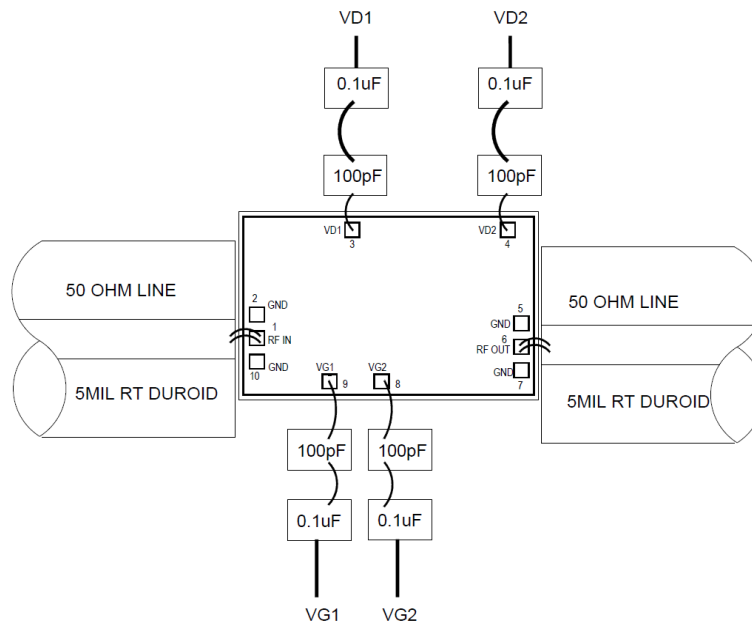

Note :

1. Two 1 mil (0.0254mm) bond wires of minimum length should be used for RF input, RF output and from chip bond pad to 100pF bypass capacitor.
2. Input and output 50 ohm lines are on 5 mil or 10 mil RT Duroid substrate.
3. The bond numbers shown in assembly diagram are as per bond pad numbers printed on the die.
4. The RF input & output ports are DC decoupled on-chip.
5. Coefficient of thermal expansion matching is recommended for reliability purpose.
6. Use high thermal conductive material for die mounting for long term reliability.
7. Maintain base plate temperature less than 70 degC under RF operation for optimum performance.

Die attach: For Epoxy attachment, use of a two-component conductive epoxy is recommended. An epoxy fillet should be visible around the total die periphery. If Eutectic attachment is preferred, use of fluxless AuSn (80/20) 1-2 mil thick preform solder is recommended. Use of AuGe preform should be strictly avoided.

Wire bonding: For DC pad connections use either ball or wedge bonds. For best RF performance, use of 150 - 200µm length of wedge bonds is advised. Single Ball bonds of 250-300µm though acceptable, may cause a deviation in RF performance.



GaAs MMIC devices are susceptible to Electrostatic discharge. Proper precautions should be observed during handling, assembly & testing

All Information and Specifications are subject to change without prior notice. Before using the product, please refer to the latest datasheet available in the website.