

0.5-30 GHz Ultra-Wideband Amplifier

Features

- ◆ Frequency Range: 0.5 – 30.0GHz
- ◆ 11.0 dB Nominal gain
- ◆ Gain Flatness: ± 2.0 dB
- ◆ Input Return Loss > 10 dB
- ◆ Output Return Loss > 10 dB
- ◆ DC decoupled input and output
- ◆ 0.15 μm InGaAs pHEMT Technology
- ◆ Chip dimension: 3.0 x 1.5 x 0.1 mm

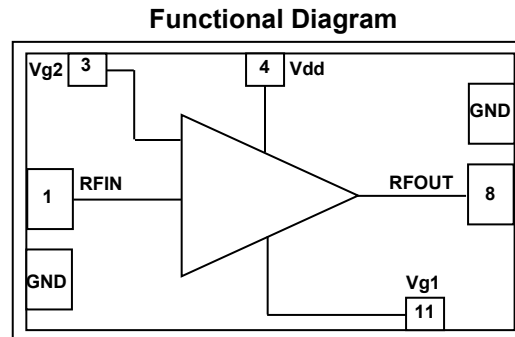

Typical Applications

- ◆ Wideband LNA/Gain block
- ◆ Electronic warfare
- ◆ Test Instrumentation

Description

The ASL5001 is an Ultra wideband pHEMT GaAs MMIC designed to operate over 0.5GHz to 30 GHz frequency range. The design employs a 7-stage, cascode-connected pHEMT structure to ensure flat gain and good return loss. The device offers a typical small signal gain of 11 dB over the operating frequency band and has a Noise figure of less than 4 dB in 3.5-18.5GHz band. The Input & output are matched to 50Ω with a VSWR better than 2:1. The chip is unconditionally stable over the frequency& bias ranges.

The ASL5001 is suitable for a variety of wideband electronic warfare systems such as radar warning receivers, jammers and instrumentation. In addition, the chip may also be used as a gain block. The die is fabricated using a reliable 0.15 μm InGaAs pHEMT technology.

Absolute Maximum Ratings ⁽¹⁾

Parameter	Absolute Maximum	Units
Positive DC voltage	+8	V
RF input power	+16	dBm
Supply Current	180	mA
Operating Temperature	-55 to +85	$^{\circ}\text{C}$
Storage Temperature	-65 to +150	$^{\circ}\text{C}$

1. Operation beyond these limits may cause permanent damage to the component

**Electrical Specifications ⁽¹⁾ @ T_A = 25 °C, Z_o =50Ω; V_{dd} = 5V, V_{g2} = 3.5V
V_{g1} =-0.3V**

Parameter	Min.	Typ. value	Max.	Units
Frequency Range	0.5	–	30.0	GHz
Gain	10	11.0	15	dB
Gain Flatness	–	± 2.0	–	dB
Noise Figure	4.0	7.0	–	dB
Input Return Loss	8	12	–	dB
Output Return Loss	8	12	–	dB
Output Power (P1 dB)	–	10	–	dBm
Saturated output power (Psat)	–	12	–	dBm
Supply voltages ^{(2),(3)}	–	V _{dd} =+5 V _{g1} =-0.3 V _{g2} =+3.5	–	V
Current	–	90	150	mA

Note:

1. Electrical specifications mentioned above are measured in a test fixture.
2. The amplifier is biased with two positive supplies (V_{dd} & V_{g2}) and a single negative gate supply (V_{G1}). The recommended bias conditions for the chip are V_{dd}=5.0V/90mA, V_{g1}=-0.3V, V_{g2}=3.5V.
3. By varying the V_{g1} & V_{g2} the gain & current can be controlled to the user requirements.

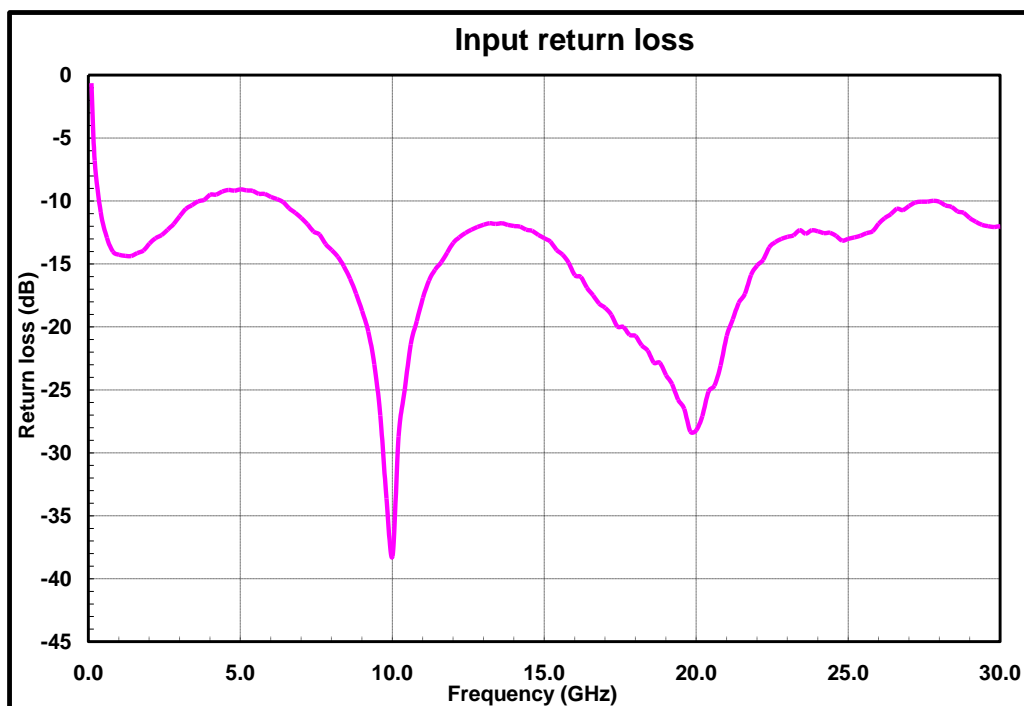
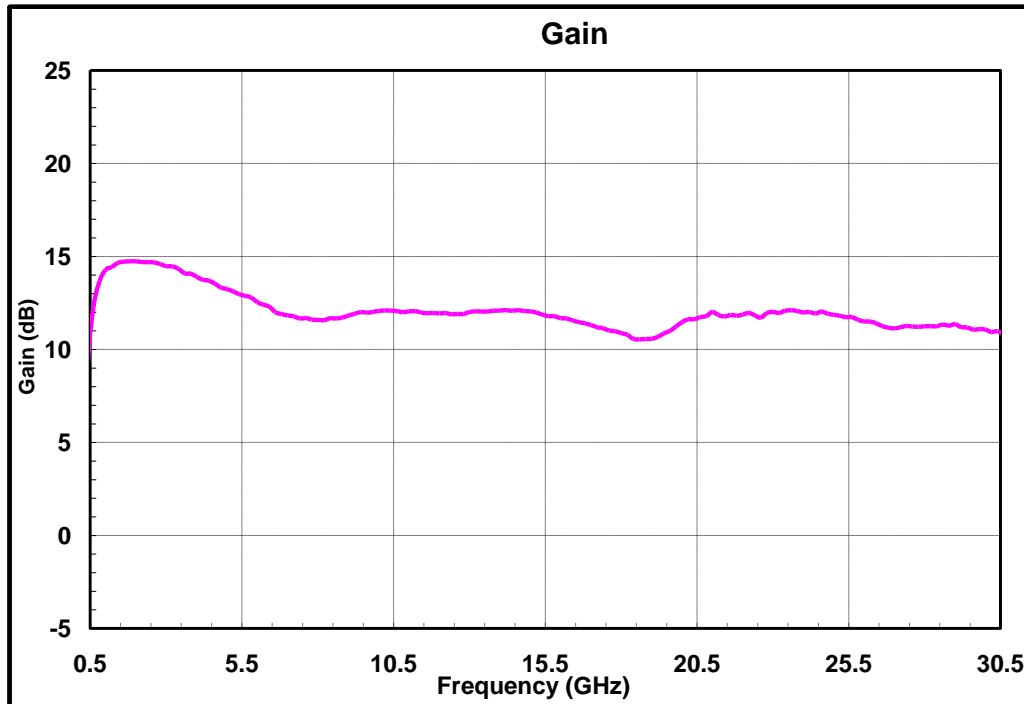
Test fixture data $V_D = +5V$, $V_{g2} = 3.5V$, $V_{g1} = -0.3V$, Total Current = 90 mA, $T_A = 25^\circ C$ 

Test fixture data

$V_D = +5V$, $V_{g2} = 3.5V$, $V_{g1} = -0.3V$, Total Current = 90 mA, $T_A = 25^\circ C$

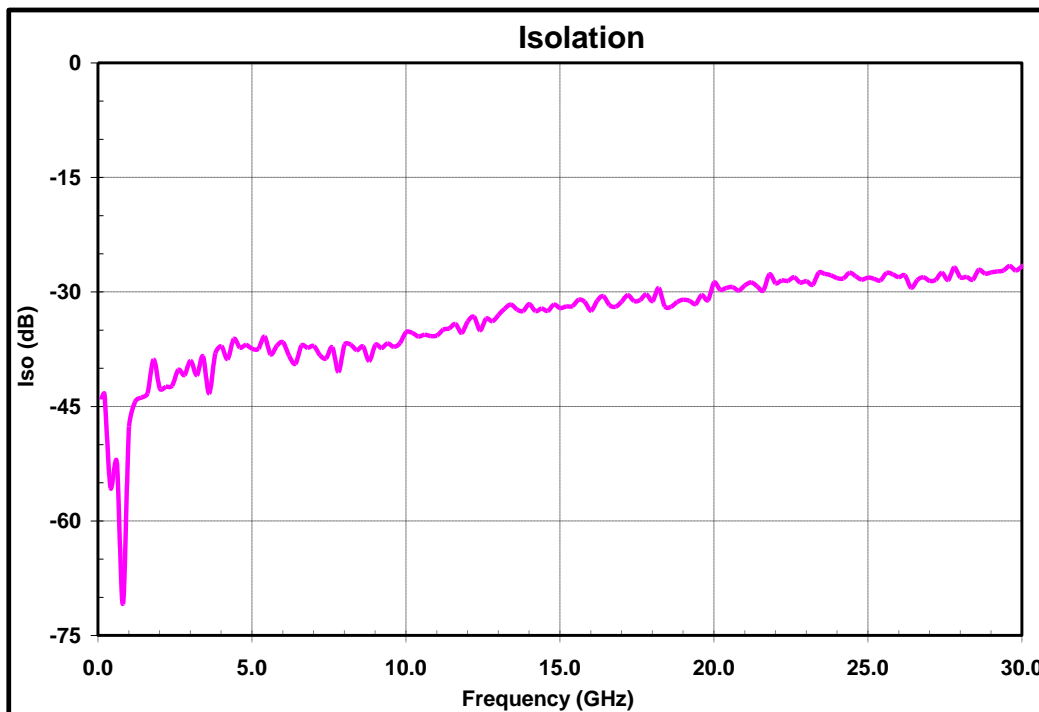
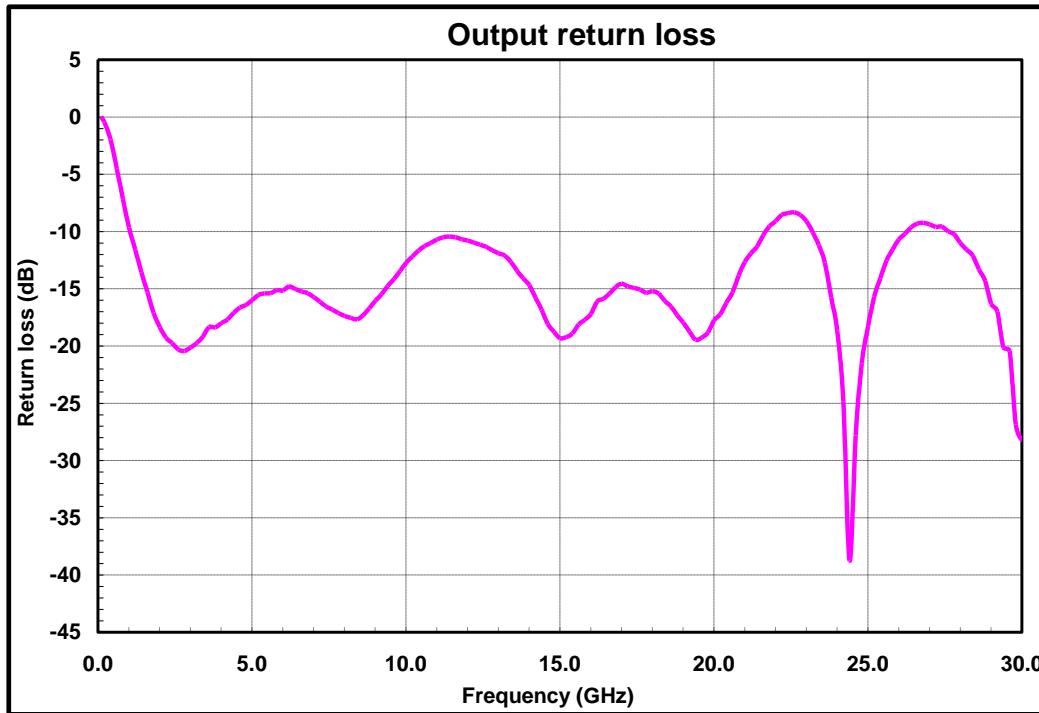

Test fixture data

$V_D = +5V$, $V_{g2} = 3.5V$, $V_{g1} = -0.3V$, Total Current = 90 mA, $T_A = 25^\circ C$

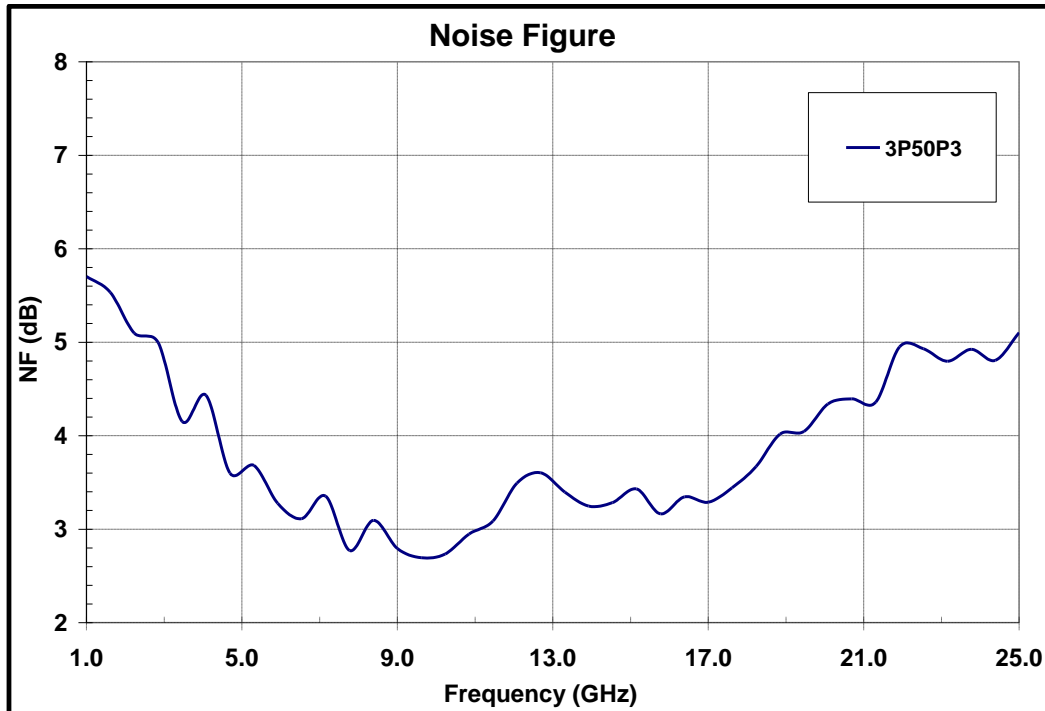

Mechanical Characteristics



Units: millimeters [inches]

All RF and DC bond pads are 100µm x 100µm

Note:

1. Pad no. 01: RF IN
2. Pad no. 03: VG2
3. Pad no. 04: VD
4. Pad no. 08: RF OUT
5. Pad no. 11: VG1
6. Pad no. 02,06,07,09,14,16: GND

Recommended Assembly Diagram

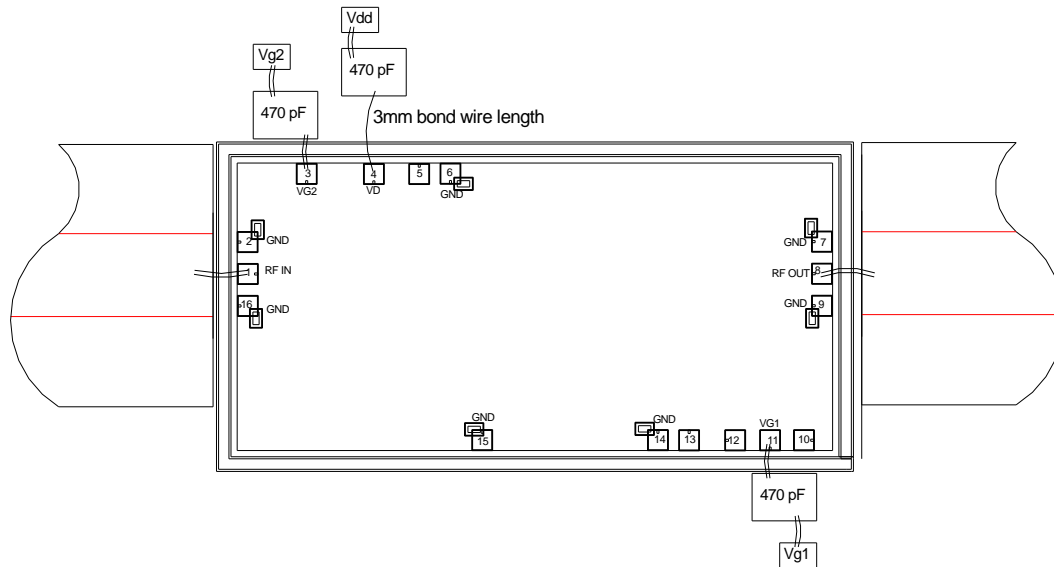

Note:

1. Two 1 mil (0.0254mm) bond wires of minimum length should be used for RF input and output.
2. 3mm long minimum bond length is to be used at the VD i.e., at Pad no. 4
3. Two 1 mil (0.0254mm) bond wires of minimum length should be used from chip bond pad to 12pF, 100pF capacitor.
4. Input and output 50 ohm lines are on 5mil Alumina/RT Duroid substrate.
5. The supply voltages are VD=5.0V, VG1=-0.3V, VG2=+4.5V
6. 0.1 μ F capacitors may be additionally used as a second level of bypass for reliable operation at the power supplies.

Die attach: For Epoxy attachment, use of a two-component conductive epoxy is recommended. An epoxy fillet should be visible around the total die periphery. If Eutectic attachment is preferred, use of fluxless AuSn (80/20) 1-2 mil thick preform solder is recommended. Use of AuGe preform should be strictly avoided.

Wire bonding: For DC pad connections use either ball or wedge bonds. For best RF performance, use of 150 - 200 μ m length of wedge bonds is advised. Single Ball bonds of 250-300 μ m though acceptable, may cause a deviation in RF performance.



GaAs MMIC devices are susceptible to Electrostatic discharge. Proper precautions should be observed during handling, assembly & testing

All information and Specifications are subject to change without prior notice

Aelius Semiconductors Pte. Ltd., Singapore

Phone: +65 68092093
 Fax: +65 63360650

Page 7 of 7

Email: info@aeliussemi.com
 URL: www.aeliussemi.com