

5.0 – 6.5 GHz 6-Bit digital Phase Shifter Module

Features

- ◆ Frequency Range: 5.0 to 6.5 GHz
- ◆ Low RMS Phase Error ~ 4°
- ◆ 8.5 dB Maximum Insertion Loss
- ◆ 13dBm Input P_{1dB}
- ◆ Integrated TTL driver
- ◆ SMA (RF) / D-type(control) interface
- ◆ ±5V supply operation
- ◆ Module dimensions : 43 mm x 45mm x16 mm

Typical Applications

- ◆ RADAR
- ◆ Instrumentation
- ◆ Test and measurement

Functional diagram

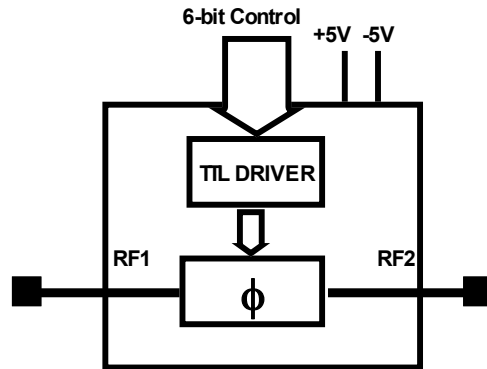

Description

The ASL10004M2 is a 6-bit digital phase shifter GaAs MMIC module designed to operate from 5.0 to 6.5 GHz. The module features a integrated TTL driver that provides the necessary digital interface for a six-bit control. The module operates on +5/-5V supply voltages with minimal current consumption.

The phase shifter has a RMS phase error within 4 deg in the designated band. The insertion loss is 8.5 dB (max.) and varies within ±1.5 dB over the band and the 64 states. The input power for 1 dB compression is 13 dBm. The RF ports are well matched to 50 Ohms. The module is rugged in construction and uses SMA connectors for the RF ports and a 15-pin standard D-type connector for the control interface.

Absolute Maximum Ratings ⁽¹⁾

Parameter	Absolute Maximum	Units
RF input Power	20	dBm
Control voltages	0.5 to +5.5V	V
Operating Temperature	-55 to +85	°C
Storage Temperature	-65 to +150	°C

1. Operation beyond these limits may cause permanent damage to the component

Electrical Specifications @ T_A = +25°C, Z₀=50Ω

Parameter	Typ.	Units
Frequency Range	5.0 - 6.5	GHz
Phase Shift	0 – 360 in 64 steps	deg
Phase Shift resolution	5.625	deg
Insertion Loss (max.)	8.5	dB
RMS Phase Shift Error (max.)	4	deg
Peak Phase Shift Error	-12 to +10	deg
Peak Amplitude Error	+/-1.5	dB
Input Return loss, all states (max.)	10	dB
Output Return Loss, all states (max.)	9	dB
DC Supply voltage	+5, -5	V
DC Current	3 - 7	mA
DC Control Voltage	ON	5
	OFF	0
Switching speed	50	ns

RF Performance

TTL Control, 50 Ohm System, $T_A = +25^\circ\text{C}$

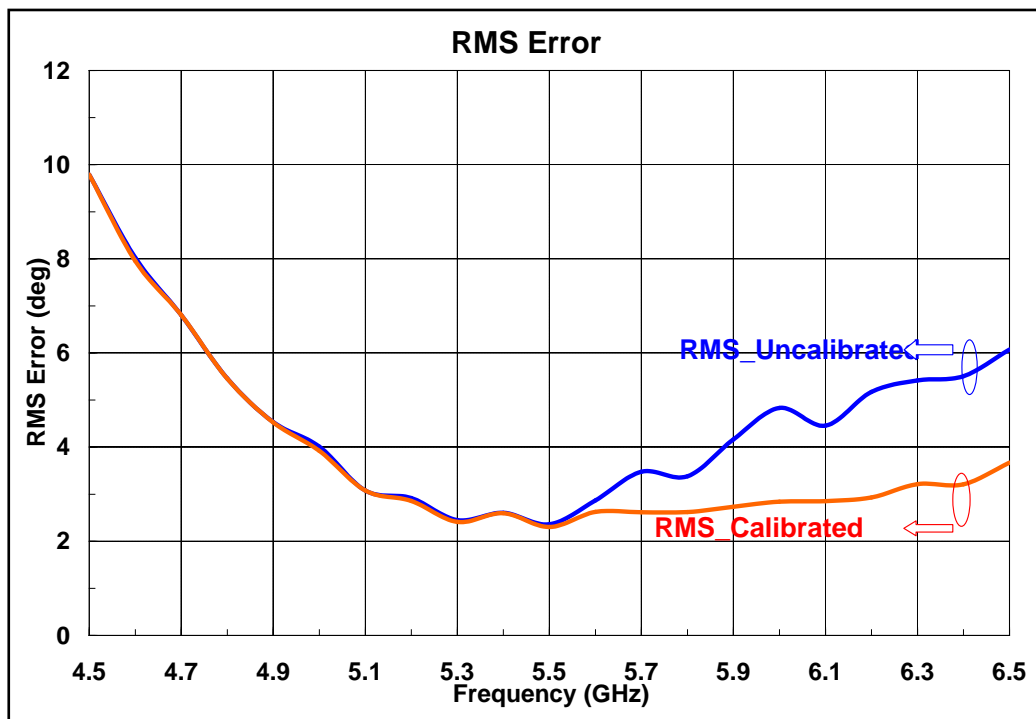
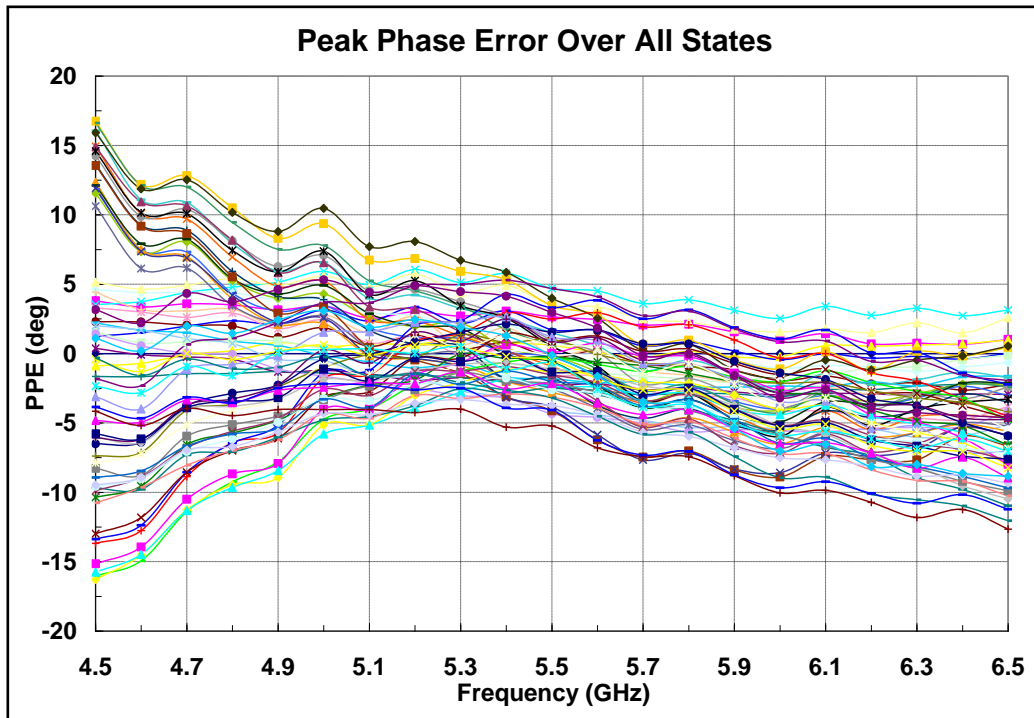

RF Performance

TTL Control, 50 Ohm System, $T_A = +25^\circ\text{C}$

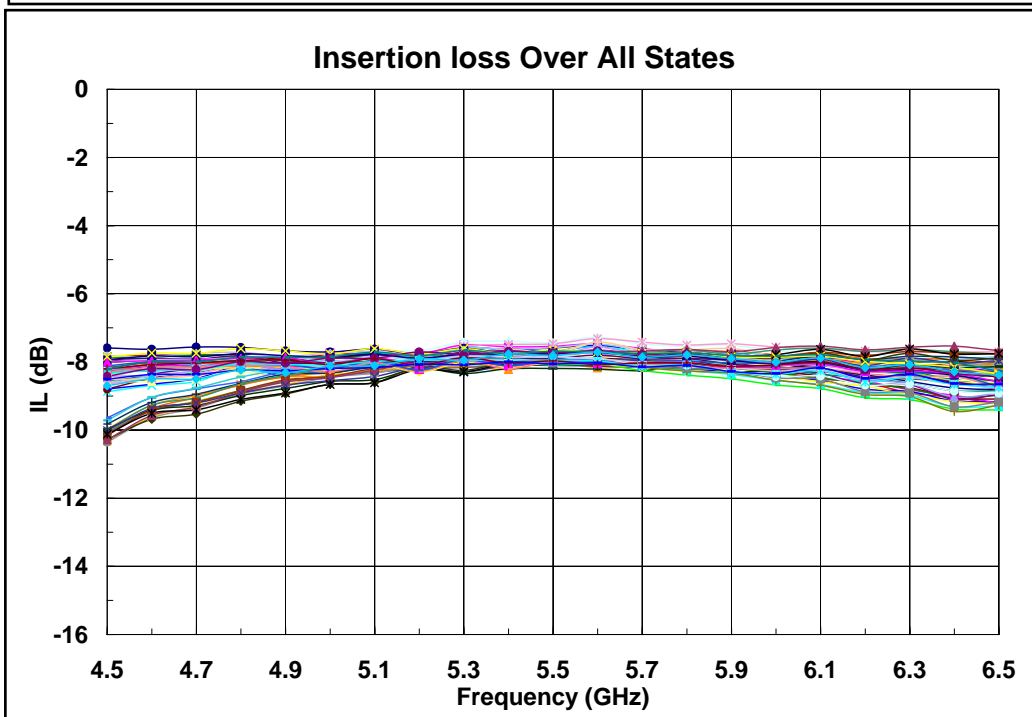
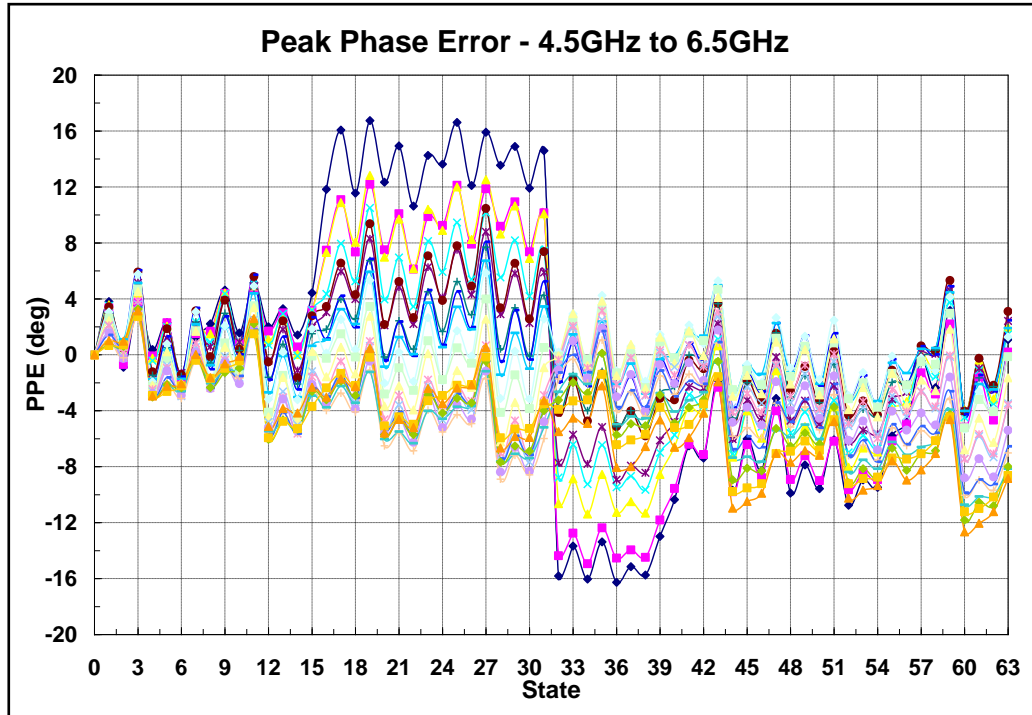

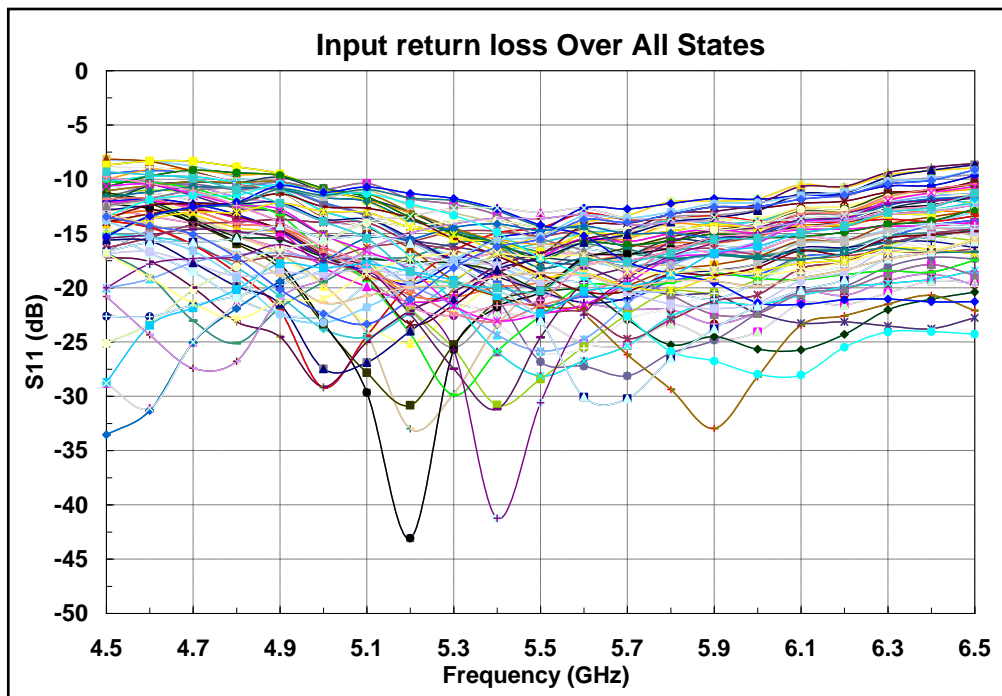
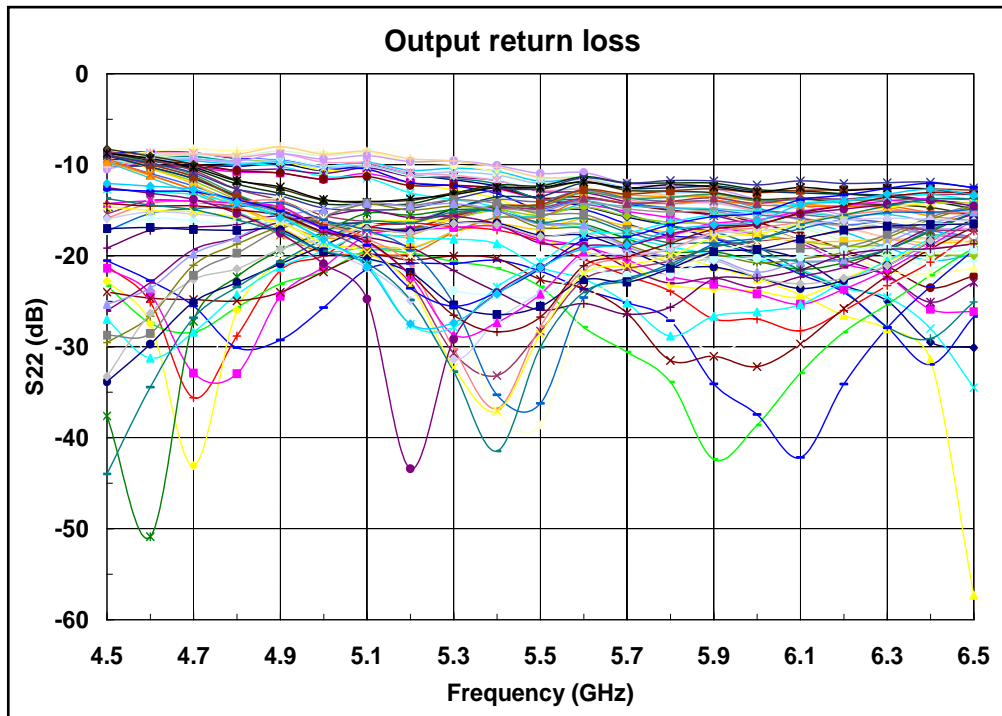
RF PerformanceTTL Control, 50 Ohm System, $T_A = +25^\circ\text{C}$ 

Mechanical Characteristics

Blas and Controls (15 PIN D-Type connector)

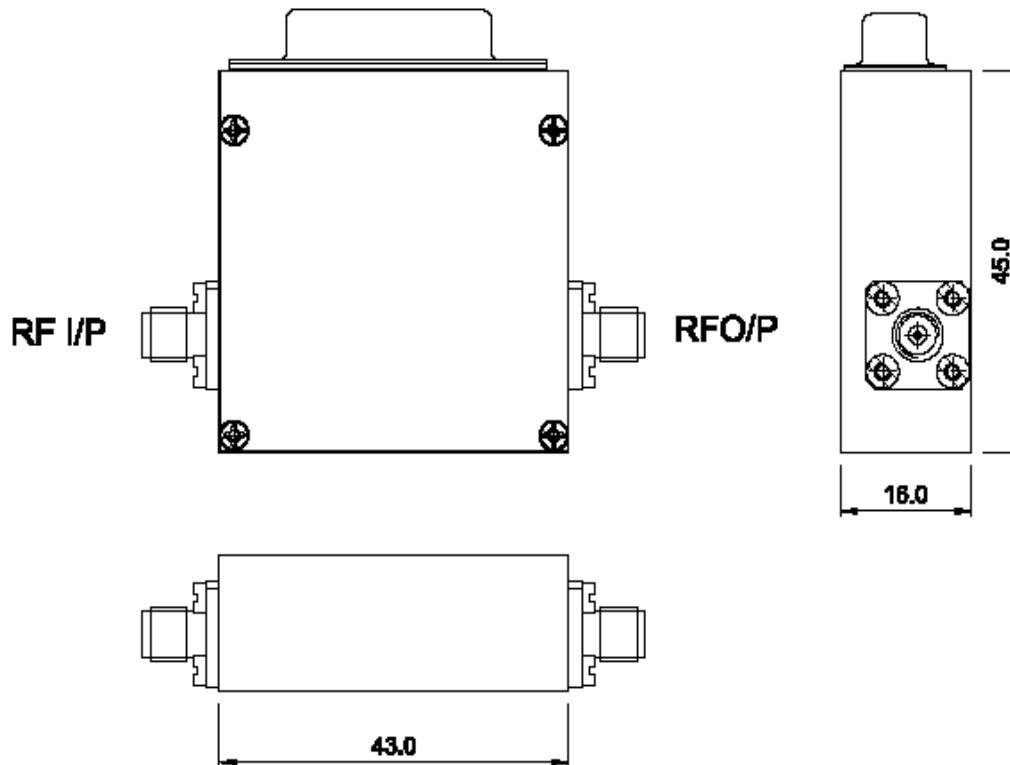

Units: Millimeters

Note:

1. Standard 15-pin D-type connector is used for the control interface
2. SMA connectors are used for the RF ports
3. The RF ports are DC coupled

D type connector Pin Configuration

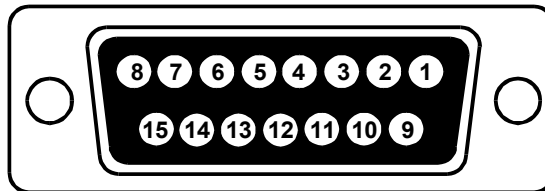

Pin No.	Function
1	5.625 deg
2	11.25 deg
3	22.5 deg
4	45 deg
5	90 deg
6	180 deg
7	+5V
8	-5V
9	NC
10	NC
11	NC
12	NC
13	NC
14	NC
15	NC

Note: The 2231021M1 module contains an internal driver that interfaces with the phase shifter.

Truth Table

State	Attenuation (dB)	TTL Control (1 = 3 to 5 V, 0 = 0 to 0.2 V)					
		180°	90°	45°	22.5°	11.25°	5.625°
		(Pin 6)	(Pin 5)	(Pin 4)	(Pin 3)	(Pin 2)	(Pin 1)
0	0	0	0	0	0	0	0
1	5.625	0	0	0	0	0	1
2	11.25	0	0	0	0	1	0
3	16.875	0	0	0	0	1	1
4	22.5	0	0	0	1	0	0
5	28.125	0	0	0	1	0	1
6	33.75	0	0	0	1	1	0
7	39.375	0	0	0	1	1	1
8	45	0	0	1	0	0	0
9	50.625	0	0	1	0	0	1
10	56.25	0	0	1	0	1	0
11	61.875	0	0	1	0	1	1
12	67.5	0	0	1	1	0	0
13	73.125	0	0	1	1	0	1
14	78.75	0	0	1	1	1	0
15	84.375	0	0	1	1	1	1
16	90	0	1	0	0	0	0
17	95.625	0	1	0	0	0	1
18	101.25	0	1	0	0	1	0
19	106.875	0	1	0	0	1	1
20	112.5	0	1	0	1	0	0
21	118.125	0	1	0	1	0	1
22	123.75	0	1	0	1	1	0
23	129.375	0	1	0	1	1	1
24	135	0	1	1	0	0	0
25	140.625	0	1	1	0	0	1
26	146.25	0	1	1	0	1	0
27	151.875	0	1	1	0	1	1
28	157.5	0	1	1	1	0	0
29	163.125	0	1	1	1	0	1
30	168.75	0	1	1	1	1	0
31	174.375	0	1	1	1	1	1
32	180	1	0	0	0	0	0
33	185.625	1	0	0	0	0	1
34	191.25	1	0	0	0	1	0
35	196.875	1	0	0	0	1	1

Truth Table

State	Attenuation (dB)	TTL Control (1 = 3 to 5 V, 0 = 0 to 0.2 V)					
		180°	90°	45°	22.5°	11.25°	5.625°
		(Pin 6)	(Pin 5)	(Pin 4)	(Pin 3)	(Pin 2)	(Pin 1)
36	202.5	1	0	0	1	0	0
37	208.125	1	0	0	1	0	1
38	213.75	1	0	0	1	1	0
39	219.375	1	0	0	1	1	1
40	225	1	0	1	0	0	0
41	230.625	1	0	1	0	0	1
42	236.25	1	0	1	0	1	0
43	241.875	1	0	1	0	1	1
44	247.5	1	0	1	1	0	0
45	253.125	1	0	1	1	0	1
46	258.75	1	0	1	1	1	0
47	264.375	1	0	1	1	1	1
48	270	1	1	0	0	0	0
49	275.625	1	1	0	0	0	1
50	281.25	1	1	0	0	1	0
51	286.875	1	1	0	0	1	1
52	292.5	1	1	0	1	0	0
53	298.125	1	1	0	1	0	1
54	303.75	1	1	0	1	1	0
55	309.375	1	1	0	1	1	1
56	315	1	1	1	0	0	0
57	320.625	1	1	1	0	0	1
58	326.25	1	1	1	0	1	0
59	331.875	1	1	1	0	1	1
60	337.5	1	1	1	1	0	0
61	343.125	1	1	1	1	0	1
62	348.75	1	1	1	1	1	0
63	354.375	1	1	1	1	1	1



GaAs MMIC devices are susceptible to Electrostatic discharge. Proper precautions should be observed during handling, assembly & testing

All information and Specifications are subject to change without prior notice