

14.5-18.5 GHz 6-Bit Digital Attenuator

Features

- ◆ Frequency Range : 14.5 to 18.5 GHz
- ◆ 31.5dB Attenuation Range
- ◆ 3.25 dB Insertion loss max.
- ◆ 1.4 :1 Input/Output VSWR
- ◆ < 0.8 dB RMS Error
- ◆ TTL Control Inputs
- ◆ 0.5 μ m InGaAs pHEMT Technology
- ◆ Chip Size : 2.4 mm x 1.7 mm x 0.1 mm

Functional Diagram

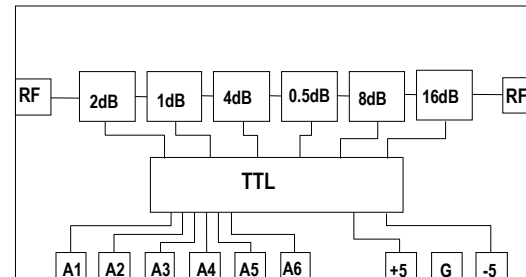

Typical Applications

- ◆ Radar
- ◆ Military & Space
- ◆ Instrumentation
- ◆ Test and Measurements
- ◆ Instrumentation Applications

Description

The AMT2351031 is a 6-bit digital attenuator MMIC offering an attenuation range of 31.5dB in steps of 0.5dB. The attenuator bit values are 0.5dB (LSB), 1,2,4,8 and 16dB (MSB) for a total attenuation of 31.5dB. The attenuator features an excellent attenuation accuracy of 2.5dB over all 64 states. The attenuator provides an integral TTL driver, facilitating a 6-bit control. The driver operates on +5/-5V voltages with minimal DC power consumption. The MMIC die is fabricated using a robust 0.5 μ m InGaAs pHEMT technology.

Absolute Maximum Ratings ⁽¹⁾

| Parameter | Absolute Maximum | Units |
|-------------------------|------------------|-------|
| RF Input Power | 25 | dBm |
| Positive Supply Voltage | +6 | V |
| Negative Supply Voltage | -6 | V |
| Control Voltage | -0.5 to +5.5 | V |
| Operating Temperature | -55 to +85 | °C |
| Storage Temperature | -65 to +150 | °C |

1. Operation beyond these limits may cause permanent damage to the component

Electrical Specifications ⁽¹⁾ @ T_A = 25 °C, Z_o =50 Ω

| Parameter | Value | Units |
|--------------------------------------|-------------|-------|
| Frequency Range | 14.5 – 18.5 | GHz |
| Insertion Loss | 3.25 | dB |
| Attenuation Range | 0-31.5 | dB |
| Attenuation step | 0.5 | dB |
| Attenuation Accuracy (All States) | 2.5 | dB |
| RMS Error | < 0.8 | dB |
| Input/Output VSWR | 1.4 : 1 | |
| DC Supply | +5/6 , -5/3 | V/mA |
| Control Voltage | 0/+5 | V |

Note:

1. The above mentioned electrical specifications are measured On-Wafer.

On Wafer data

$T_A = 25\text{ }^\circ\text{C}$

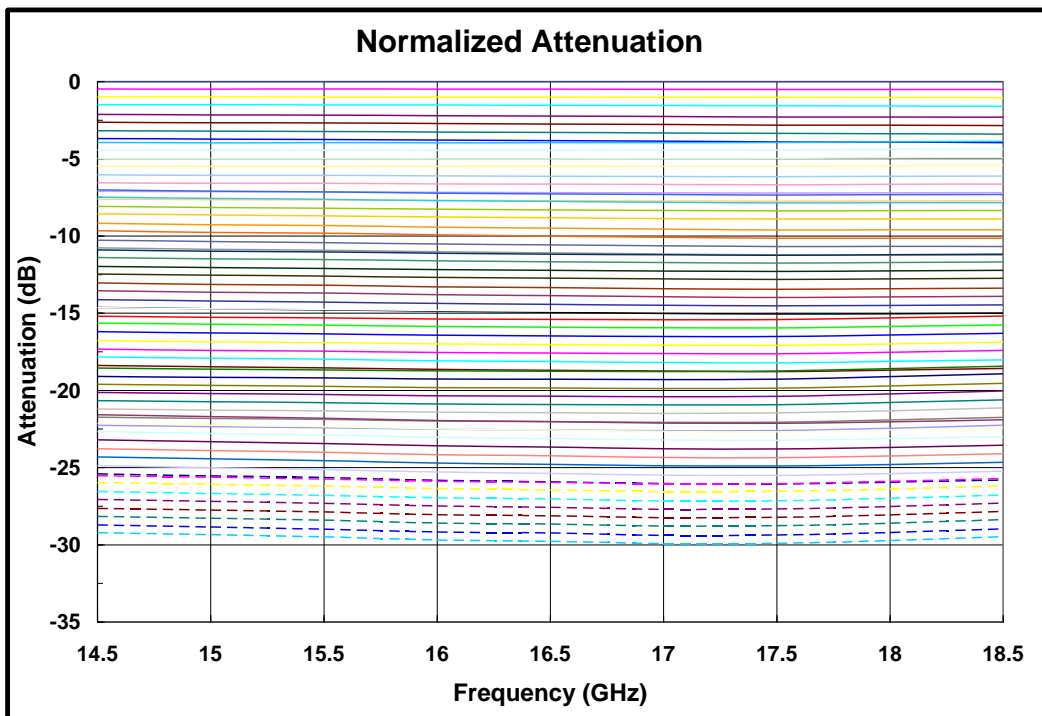
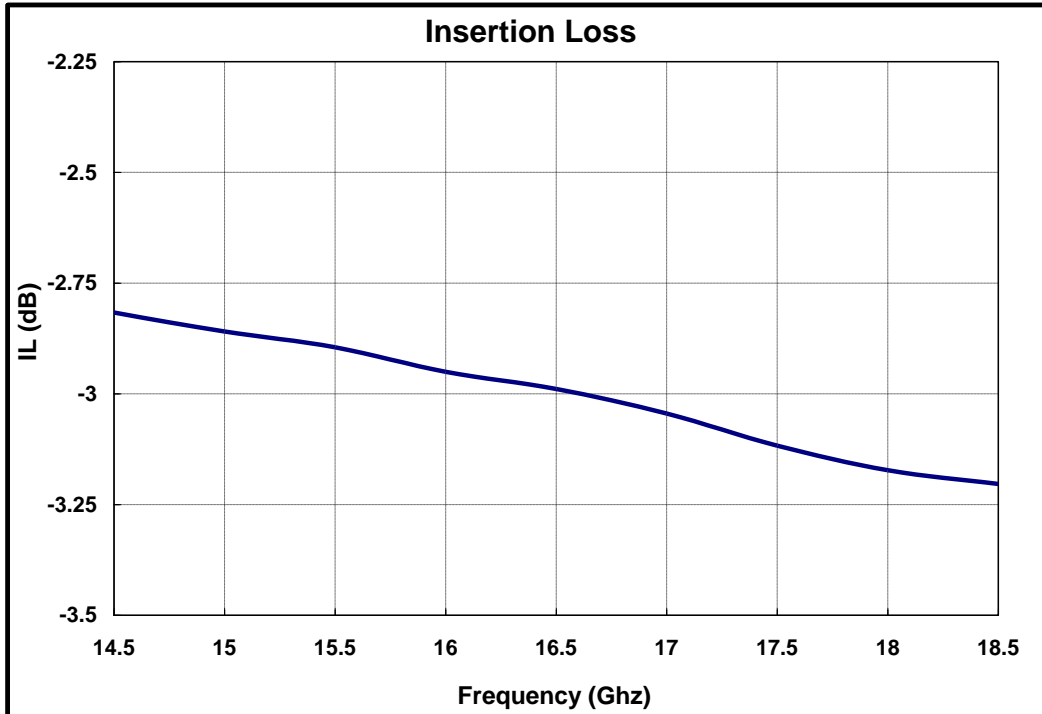

On Wafer data

$T_A = 25\text{ }^\circ\text{C}$

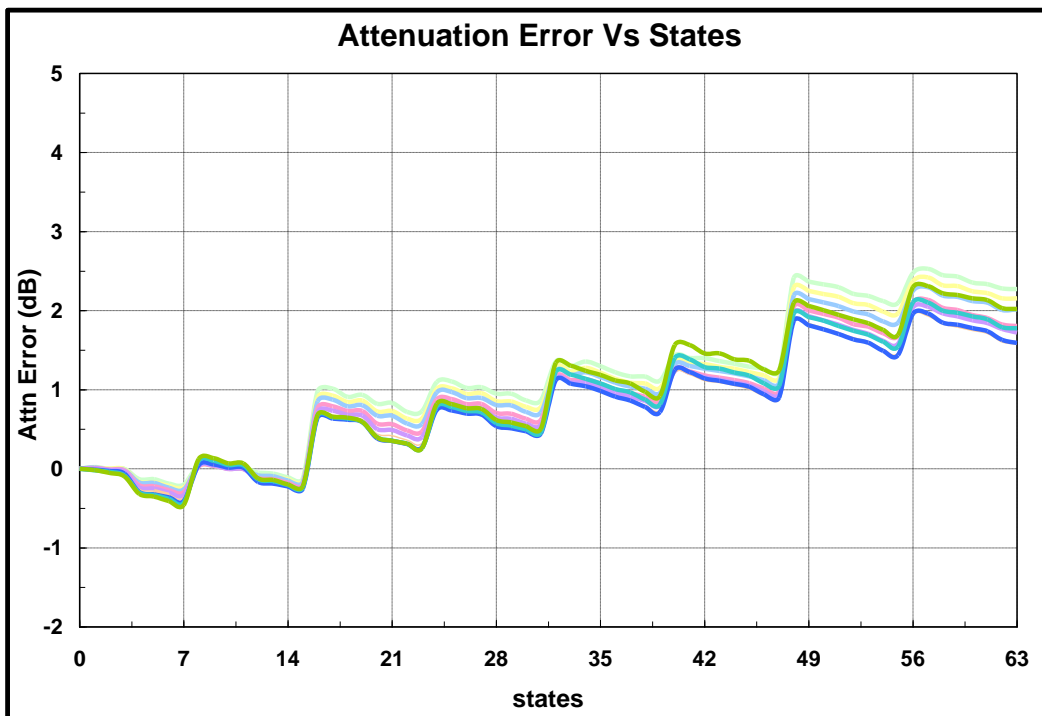
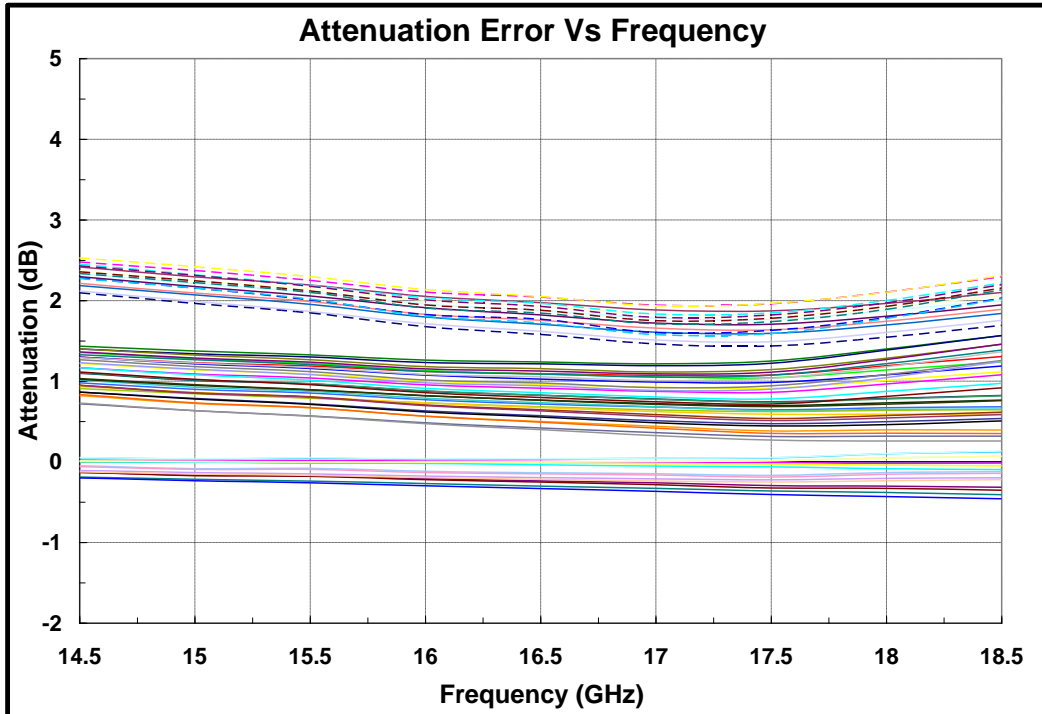

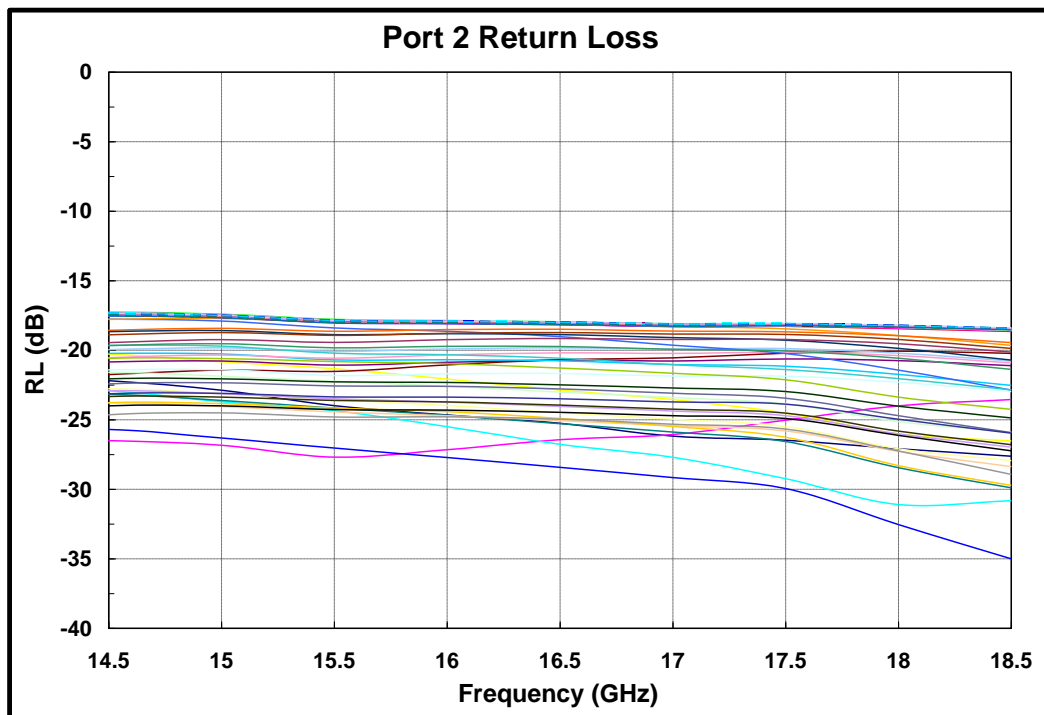
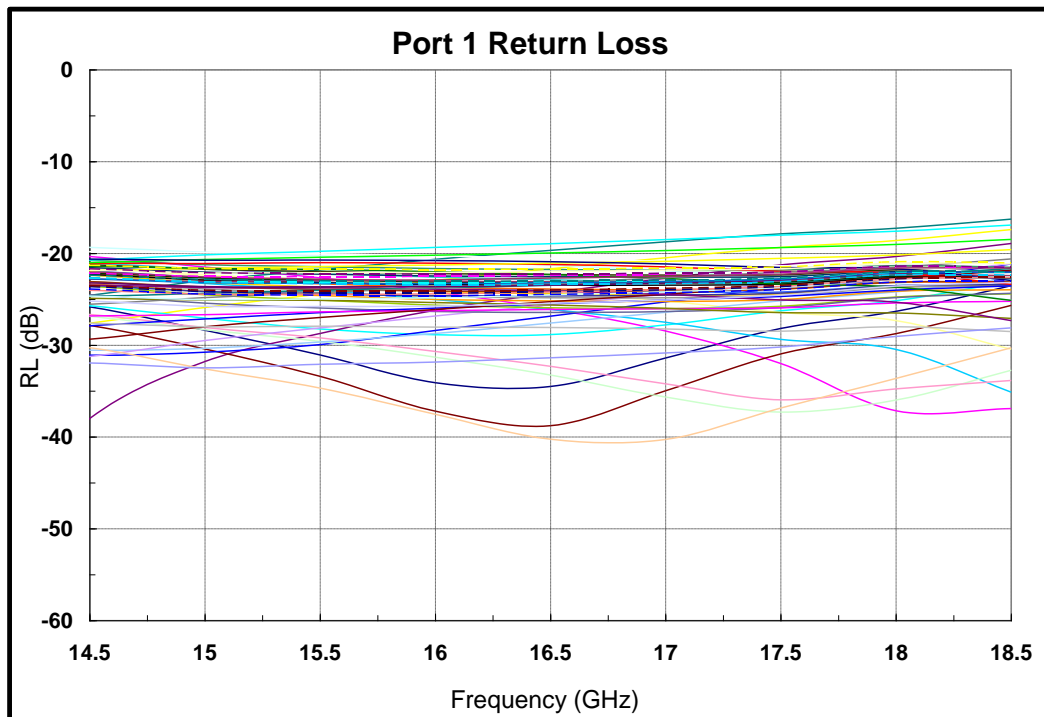
On Wafer data $T_A = 25^\circ\text{C}$ 

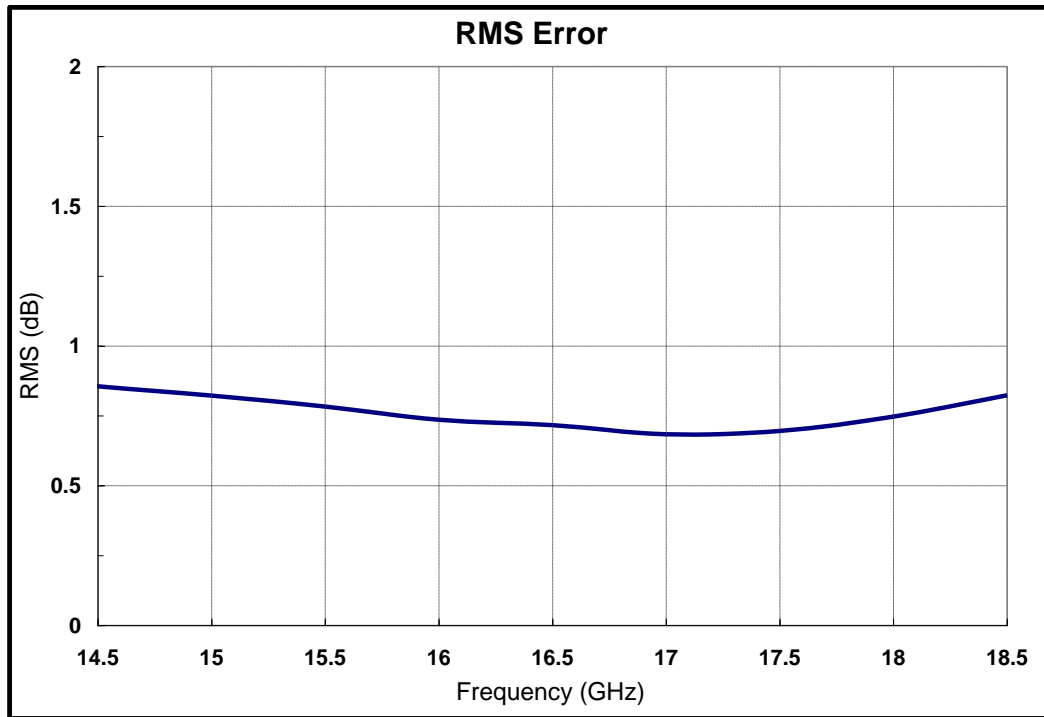
On Wafer data $T_A = 25^\circ\text{C}$ 

Truth Table

| State | Attenuation (dB) | TTL Control (1 = 3 to 5 V, 0 = 0 to 0.5 V) | | | | | |
|-------|------------------|--|--------|-------|--------|-------|----------|
| | | A6 (16) | A5 (8) | A4(4) | A3 (2) | A2(1) | A1 (0.5) |
| 0 | 0 | 0 | 0 | 0 | 0 | 0 | 0 |
| 1 | 0.5 | 0 | 0 | 0 | 0 | 0 | 1 |
| 2 | 1 | 0 | 0 | 0 | 0 | 1 | 0 |
| 3 | 1.5 | 0 | 0 | 0 | 0 | 1 | 1 |
| 4 | 2 | 0 | 0 | 0 | 1 | 0 | 0 |
| 5 | 2.5 | 0 | 0 | 0 | 1 | 0 | 1 |
| 6 | 3 | 0 | 0 | 0 | 1 | 1 | 0 |
| 7 | 3.5 | 0 | 0 | 0 | 1 | 1 | 1 |
| 8 | 4 | 0 | 0 | 1 | 0 | 0 | 0 |
| 9 | 4.5 | 0 | 0 | 1 | 0 | 0 | 1 |
| 10 | 5 | 0 | 0 | 1 | 0 | 1 | 0 |
| 11 | 5.5 | 0 | 0 | 1 | 0 | 1 | 1 |
| 12 | 6 | 0 | 0 | 1 | 1 | 0 | 0 |
| 13 | 6.5 | 0 | 0 | 1 | 1 | 0 | 1 |
| 14 | 7 | 0 | 0 | 1 | 1 | 1 | 0 |
| 15 | 7.5 | 0 | 0 | 1 | 1 | 1 | 1 |
| 16 | 8 | 0 | 1 | 0 | 0 | 0 | 0 |
| 17 | 8.5 | 0 | 1 | 0 | 0 | 0 | 1 |
| 18 | 9 | 0 | 1 | 0 | 0 | 1 | 0 |
| 19 | 9.5 | 0 | 1 | 0 | 0 | 1 | 1 |
| 20 | 10 | 0 | 1 | 0 | 1 | 0 | 0 |
| 21 | 10.5 | 0 | 1 | 0 | 1 | 0 | 1 |
| 22 | 11 | 0 | 1 | 0 | 1 | 1 | 0 |
| 23 | 11.5 | 0 | 1 | 0 | 1 | 1 | 1 |
| 24 | 12 | 0 | 1 | 1 | 0 | 0 | 0 |
| 25 | 12.5 | 0 | 1 | 1 | 0 | 0 | 1 |
| 26 | 13 | 0 | 1 | 1 | 0 | 1 | 0 |
| 27 | 13.5 | 0 | 1 | 1 | 0 | 1 | 1 |
| 28 | 14 | 0 | 1 | 1 | 1 | 0 | 0 |
| 29 | 14.5 | 0 | 1 | 1 | 1 | 0 | 1 |
| 30 | 15 | 0 | 1 | 1 | 1 | 1 | 0 |
| 31 | 15.5 | 0 | 1 | 1 | 1 | 1 | 1 |
| 32 | 16 | 1 | 0 | 0 | 0 | 0 | 0 |
| 33 | 16.5 | 1 | 0 | 0 | 0 | 0 | 1 |
| 34 | 17 | 1 | 0 | 0 | 0 | 1 | 0 |
| 35 | 17.5 | 1 | 0 | 0 | 0 | 1 | 1 |

Truth Table

| State | Attenuation (dB) | TTL Control (1 = 3 to 5 V, 0 = 0 to 0.5 V) | | | | | |
|-------|------------------|--|--------|-------|--------|-------|----------|
| | | A6 (16) | A5 (8) | A4(4) | A3 (2) | A2(1) | A1 (0.5) |
| 36 | 18.0 | 1 | 0 | 0 | 1 | 0 | 0 |
| 37 | 18.5 | 1 | 0 | 0 | 1 | 0 | 1 |
| 38 | 19 | 1 | 0 | 0 | 1 | 1 | 0 |
| 39 | 19.5 | 1 | 0 | 0 | 1 | 1 | 1 |
| 40 | 20 | 1 | 0 | 1 | 0 | 0 | 0 |
| 41 | 20.5 | 1 | 0 | 1 | 0 | 0 | 1 |
| 42 | 21 | 1 | 0 | 1 | 0 | 1 | 0 |
| 43 | 21.5 | 1 | 0 | 1 | 0 | 1 | 1 |
| 44 | 22 | 1 | 0 | 1 | 1 | 0 | 0 |
| 45 | 22.5 | 1 | 0 | 1 | 1 | 0 | 1 |
| 46 | 23 | 1 | 0 | 1 | 1 | 1 | 0 |
| 47 | 23.5 | 1 | 0 | 1 | 1 | 1 | 1 |
| 48 | 24 | 1 | 1 | 0 | 0 | 0 | 0 |
| 49 | 24.5 | 1 | 1 | 0 | 0 | 0 | 1 |
| 50 | 25 | 1 | 1 | 0 | 0 | 1 | 0 |
| 51 | 25.5 | 1 | 1 | 0 | 0 | 1 | 1 |
| 52 | 26 | 1 | 1 | 0 | 1 | 0 | 0 |
| 53 | 26.5 | 1 | 1 | 0 | 1 | 0 | 1 |
| 54 | 27 | 1 | 1 | 0 | 1 | 1 | 0 |
| 55 | 27.5 | 1 | 1 | 0 | 1 | 1 | 1 |
| 56 | 28 | 1 | 1 | 1 | 0 | 0 | 0 |
| 57 | 28.5 | 1 | 1 | 1 | 0 | 0 | 1 |
| 58 | 29 | 1 | 1 | 1 | 0 | 1 | 0 |
| 59 | 29.5 | 1 | 1 | 1 | 0 | 1 | 1 |
| 60 | 30 | 1 | 1 | 1 | 1 | 0 | 0 |
| 61 | 30.5 | 1 | 1 | 1 | 1 | 0 | 1 |
| 62 | 31 | 1 | 1 | 1 | 1 | 1 | 0 |
| 63 | 31.5 | 1 | 1 | 1 | 1 | 1 | 1 |

Mechanical Characteristics

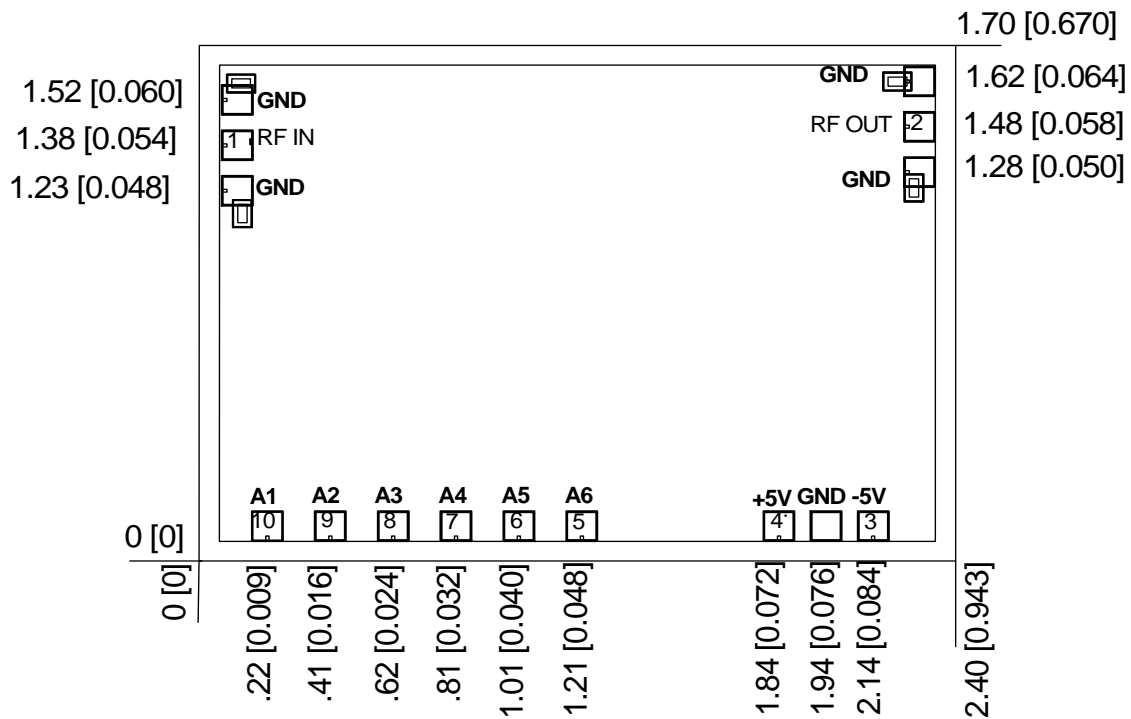

Units: millimeters (inches)

Note:

1. All RF and DC bond pads are 100µm x 100µm
2. Pad no.1: RF Port 1
3. Pad no.2: RF Port 2
4. Pad no.3: -5V
5. Pad no.4: +5V
6. Pad nos.5 -10: Control pads; Pad 5: MSB(16dB) & Pad 10: LSB (0.5dB)

Recommended Assembly Diagram

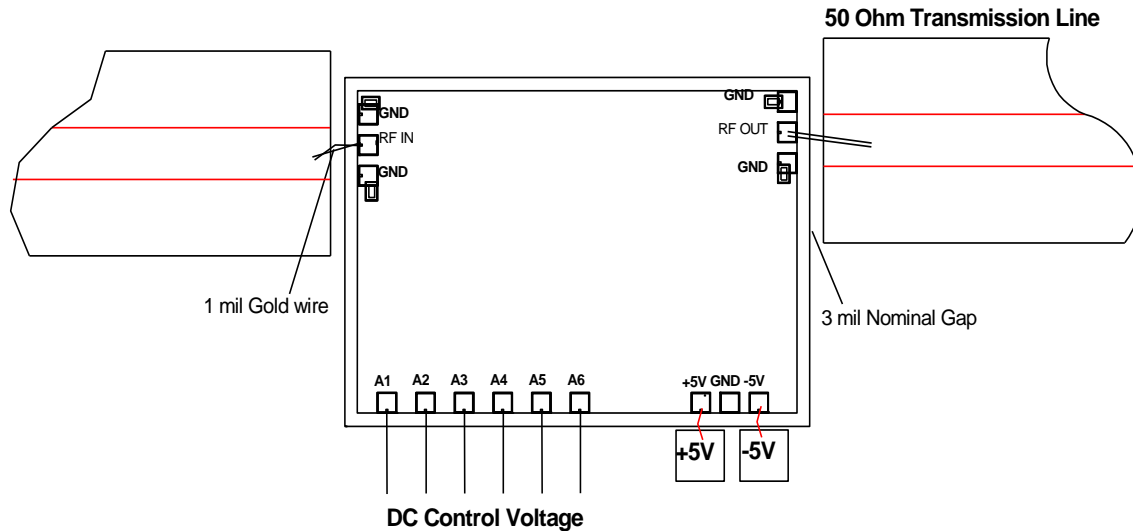

Note:

1. The RF input & output ports are DC coupled
2. No external components are required for this chip

Die attach: For Epoxy attachment, use of a two-component conductive epoxy is recommended. An epoxy fillet should be visible around the total die periphery. If Eutectic attachment is preferred, use of fluxless AuSn (80/20) 1-2 mil thick preform solder is recommended. Use of AuGe preform should be strictly avoided.

Wire bonding: For DC pad connections use either ball or wedge bonds. For best RF performance, use of 150 - 200 μ m length of wedge bonds is advised. Single Ball bonds of 250-300 μ m though acceptable, may cause a deviation in RF performance.



GaAs MMIC devices are susceptible to Electrostatic discharge. Proper precautions should be observed during handling, assembly & testing

All information and Specifications are subject to change without prior notice