

## 3.0 – 4.0 GHz Ultra Low Noise Amplifier

### Features

- ◆ Frequency Range : 3.0 – 4.0GHz
- ◆ Ultra low noise figure < 1.25 dB
- ◆ High Gain ~ 35 dB
- ◆ 18 dBm Nominal P1 dB
- ◆ Input Return Loss > 12 dB
- ◆ Output Return Loss > 18 dB
- ◆ Single supply operation
- ◆ No external matching required
- ◆ DC decoupled input and output
- ◆ 0.15  $\mu\text{m}$  InGaAs pHEMT Technology
- ◆ Chip dimension: 3.9 x 2.1 x 0.1 mm

**Functional diagram**

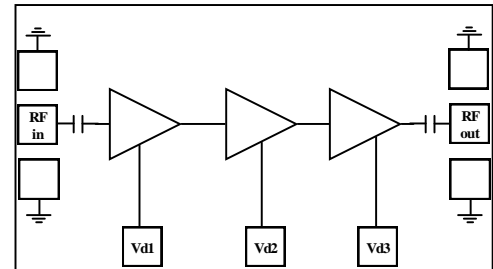

### Typical Applications

- ◆ Radar
- ◆ Military
- ◆ Test Equipment and Sensors
- ◆ Point-to-Point Radios, Point-to-Multi-Point Radios & VSATS

### Description

The ASL1011 is an Ultra Low Noise Amplifier operating in 3.0 -4.0 GHz frequency range. The LNA uses 3 stages of amplification and provides a high gain of 35 dB with a noise figure of 1.25 dB. The typical input and output return loss are better than 13 dB and 18 dB respectively. The LNA delivers a minimum P1 dB of 17 dBm over the entire operating band. The chip operates from a single positive supply. The RF ports are DC decoupled on chip. The Circuit grounds are provided through vias to the backside metallization. The die is fabricated using a reliable 0.15 $\mu\text{m}$  InGaAs pHEMT technology. The die is suitable in applications where high gain, very low noise and excellent linearity are desired.

### Absolute Maximum Ratings<sup>(1)</sup>

Parameter	Absolute Maximum	Units
Positive DC voltage	+7	V
RF input power	+15	dBm
Supply Current	220	mA
Operating Temperature	-55 to +85	°C
Storage Temperature	-65 to +150	°C

1. Operation beyond these limits may cause permanent damage to the component

**Electrical Specifications<sup>(1)</sup> @ T<sub>A</sub> = 25 °C, Z<sub>o</sub> = 50Ω; V<sub>d1</sub> = 1V, V<sub>d2</sub> = V<sub>d3</sub> = 4V**

Parameter	Min.	Typ.	Max.	Units
Frequency Range	3.0	–	4.0	GHz
Gain	32	35	37	dB
Gain Flatness	–	± 0.5	–	dB
Noise Figure	–	1.25	1.5	dB
Input Return Loss	10	13	–	dB
Output Return Loss	15	18	–	dB
Output Power (P1 dB)	16	18	–	dBm
Saturated output power (P <sub>sat</sub> )	–	20	–	dBm
Output Third Order Intercept (IP3)	–	28	–	dBm
Supply Current	110	140	170	mA

**Note:**

1. Electrical specifications as measured in a test fixture.

**Test fixture data**

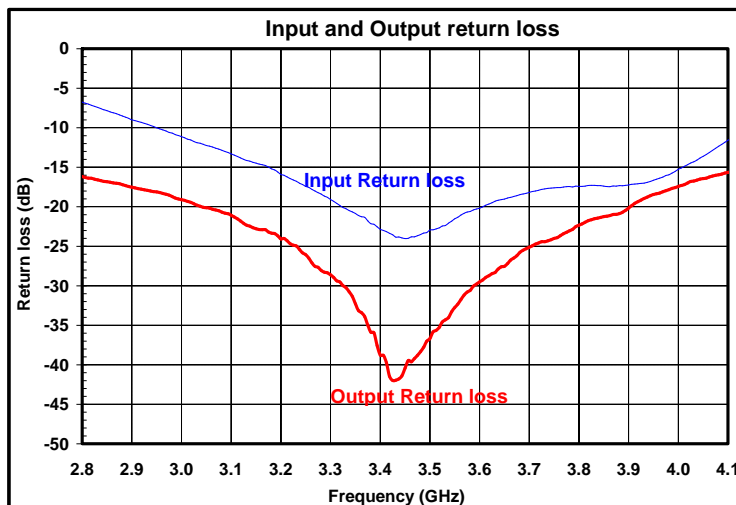
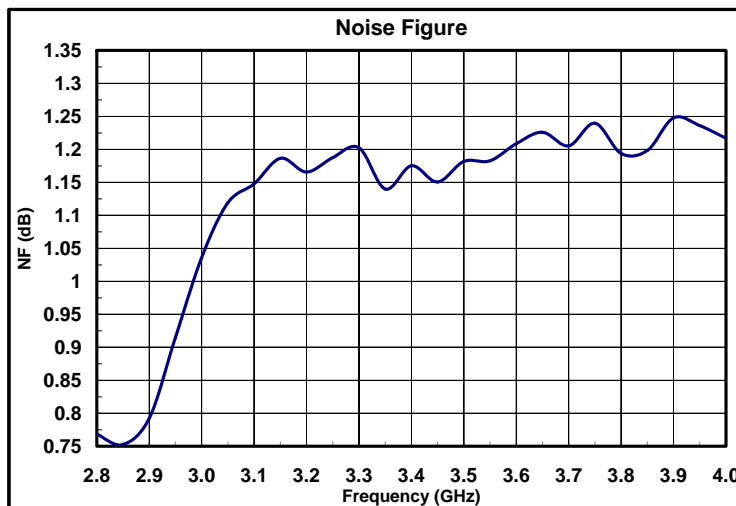
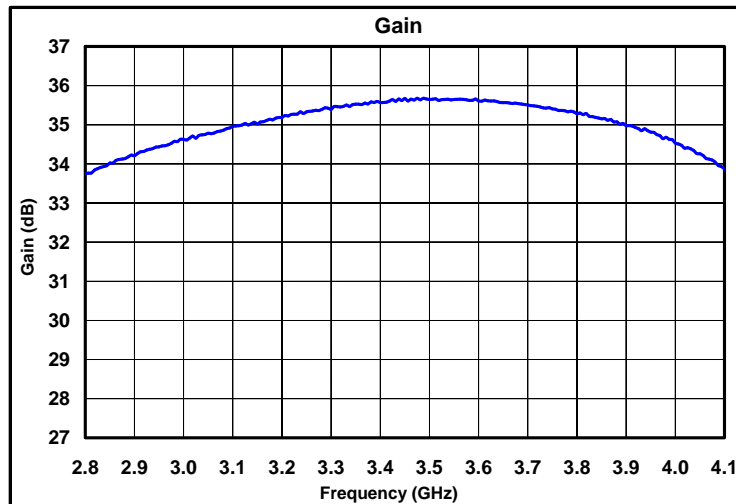
 Vd1= 1V, Vd2 = Vd3 = 4V, Total Current = 140 mA, T<sub>A</sub> = 25 °C

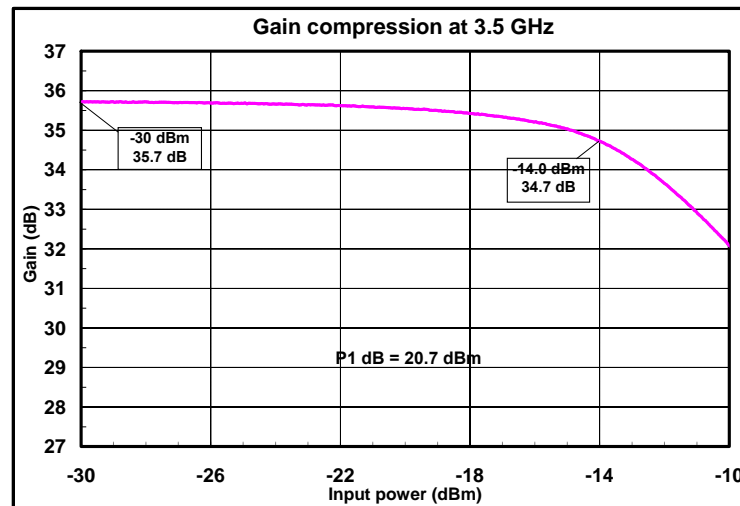
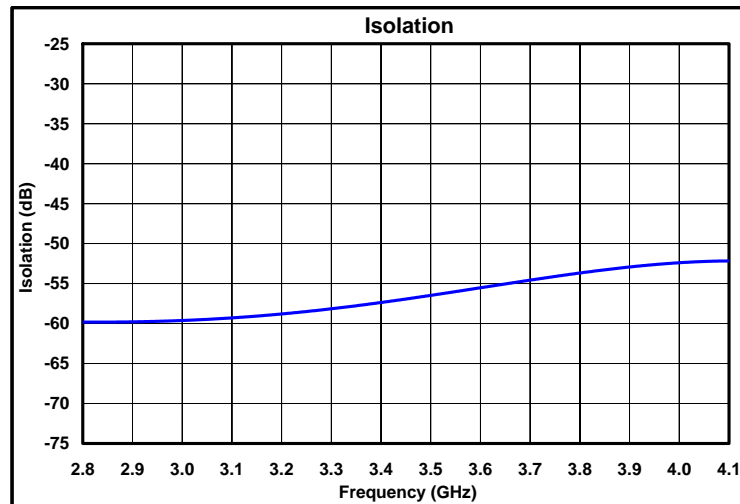
**Test fixture data**
 $Vd1 = 1V, Vd2 = Vd3 = 4V, Total\ Current = 140\ mA, T_A = 25\ ^\circ C$ 

## Mechanical Characteristics

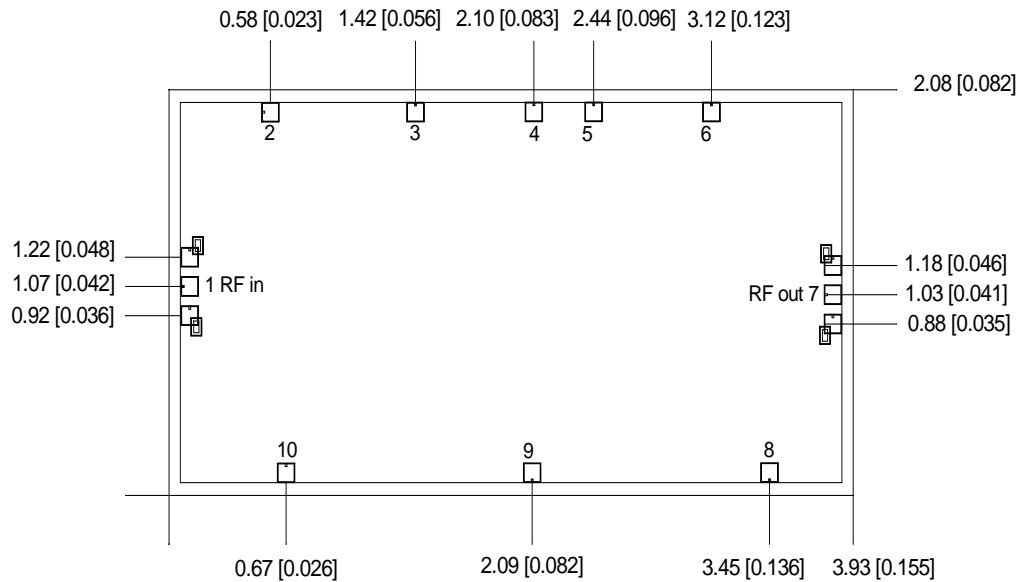

Units: millimeters (inches)

All RF and DC bond pads are 100µm x 100µm

Note:

1. Pad no. 1: RF in
2. Pad no. 2: Source bypass (200 pF)
3. Pad no. 3: Optional Vg1
4. Pad no. 4: Source bypass (100 pF)
5. Pad no. 5: Optional Vg2
6. Pad no. 6: Source bypass (100 pF)
7. Pad no. 7: RF out
8. Pad no. 8: Vd3
9. Pad no. 9: Vd2
10. Pad no. 10: Vd1

## Recommended Assembly Diagram

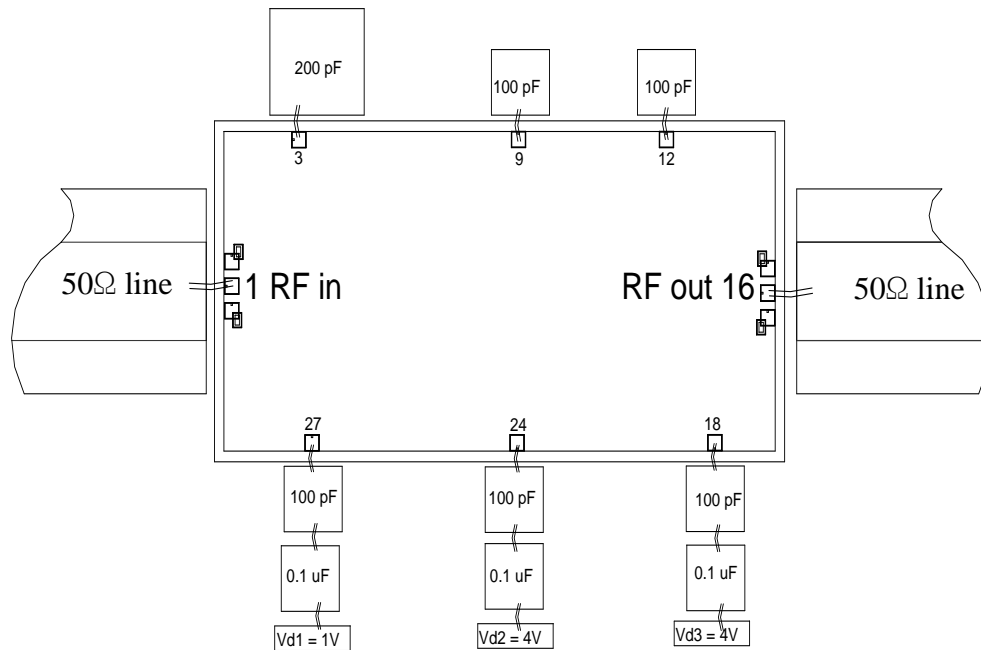

### Note :

- Two 1 mil (0.0254mm) bond wires of minimum length should be used for RF input and output.
- Two 1 mil (0.0254mm) bond wires of minimum length should be used from chip bond pad to 100pF capacitor.
- Input and output 50 ohm lines are on 5 mil RT Duroid substrate
- 0.1  $\mu$ F capacitors may be additionally used as a second level of bypass for reliable operation
- The bond numbers shown in assembly diagram are as per bond pad numbers printed on the die.
- The RF input & output ports are DC decoupled on-chip.

**Die attach:** For Epoxy attachment, use of a two-component conductive epoxy is recommended. An epoxy fillet should be visible around the total die periphery. If Eutectic attachment is preferred, use of fluxless AuSn (80/20) 1-2 mil thick preform solder is recommended. Use of AuGe preform should be strictly avoided.

**Wire bonding:** For DC pad connections use either ball or wedge bonds. For best RF performance, use of 150 - 200 $\mu$ m length of wedge bonds is advised. Single Ball bonds of 250-300 $\mu$ m though acceptable, may cause a deviation in RF performance.



**GaAs MMIC devices are susceptible to Electrostatic discharge. Proper precautions should be observed during handling, assembly & testing**

All information and Specifications are subject to change without prior notice

**Aelius Semiconductors Pte. Ltd., Singapore**

Phone : +65 68092093  
 Fax : +65 63360650

Page 6 of 6

Email: [info@aeliussemi.com](mailto:info@aeliussemi.com)  
 URL: [www.aeliussemi.com](http://www.aeliussemi.com)